

JVC



ENGLISH

中文

ไทย

CD RECEIVER

CD 收音組合機

เครื่องเล่น CD

KD-SC605

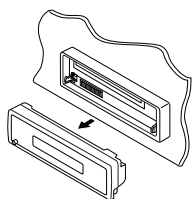
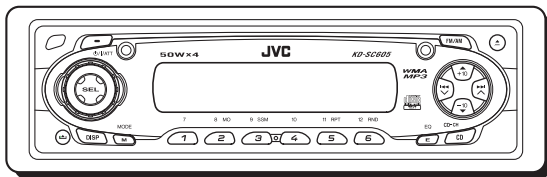

WMA
MP3

COMPACT
disc
DIGITAL AUDIO
TEXT

- This unit is equipped with the display demonstration. To cancel it, see page 8.
- 本機配備了顯示區展示螢幕，要取消顯示區展示，請參閱第 8 頁。
- เครื่องนี้ติดตั้งรายการสาธิตการทำงานบนหน้าจอ ดูวิธียกเลิกการสาธิตที่หน้า 8

For installation and connections, refer to the separate manual.

有關安裝和連接方法，分別參見操作手冊。

กรุณาดูคู่มือที่แยกต่างหาก ในการติดตั้งและการเชื่อมต่อ

INSTRUCTIONS

使用說明書

คำแนะนำ

GET0188-001A
[U]

IMPORTANT FOR LASER PRODUCTS

1. CLASS 1 LASER PRODUCT
2. **CAUTION:** Do not open the top cover. There are no user serviceable parts inside the unit; leave all servicing to qualified service personnel.
3. **CAUTION:** Visible and invisible laser radiation when open and interlock failed or defeated. Avoid direct exposure to beam.
4. REPRODUCTION OF LABEL: CAUTION LABEL, PLACED OUTSIDE THE UNIT.

CAUTION: Visible and invisible laser radiation when open and interlock failed or defeated. AVOID DIRECT EXPOSURE TO BEAM.	ADVARSEL: Synlig og usynlig laserstråling når maskinen er åben eller interlocken fejler. Undgå direkte eksponering til stråling.	VARNING: Synlig och osynlig laserstråling när den öppnas och spärren är urkopplad. Beträkta ej strålen.	VARO: Avattaessa ja suojalukitus ohitettuna tai viallisena olet alittine näkyvälle ja näkymättömälle lasersträilylle. Vältä säteen kohdistumista suoraan iiseesi. (fi)
(e)	(e)	(d)	(s)

How to reset your unit

After detaching the control panel, press the reset button on the panel holder using a ball-point pen or a similar tool.

This will reset the built-in microcomputer.

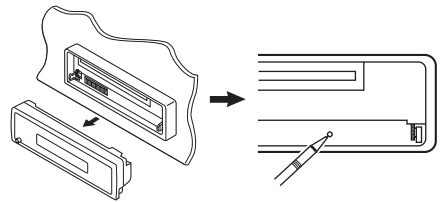

Note:

Your preset adjustments—such as preset channels or sound adjustments—will also be erased.

How to use the M MODE button

If you press M MODE, the unit goes into functions mode, then the number buttons and ▲/▼ buttons work as different function buttons.

Ex.: When number button 2 works as MO (monaural) button.

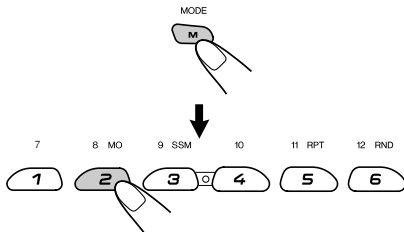

Time countdown indicator

To use these buttons for original functions again after pressing M MODE, wait for 5 seconds without pressing any of these buttons until the functions mode is cleared.

- Pressing M MODE again also clears the functions mode.

Thank you for purchasing a JVC product. Please read all instructions carefully before operation, to ensure your complete understanding and to obtain the best possible performance from the unit.

CONTENTS

How to reset your unit	2	MP3/WMA OPERATIONS	18
How to use the M MODE button	2	Playing a disc	18
LOCATION OF THE BUTTONS	4	Locating a file or particular portion on a disc	19
Control panel	4	Selecting playback modes	21
Remote controller	5	SOUND ADJUSTMENTS	23
Preparing the remote controller	6	Selecting preset sound modes (C-EQ: custom equalizer)	23
BASIC OPERATIONS	7	Adjusting the sound	24
Turning on the power	7	OTHER MAIN FUNCTIONS	25
Canceling the display demonstration	8	Changing the general settings (PSM)	25
Setting the clock	9	Assigning names to the sources	29
RADIO OPERATIONS	10	Changing the standard plate	30
Listening to the radio	10	Detaching the control panel	32
Storing stations in memory	11	CD CHANGER OPERATIONS	33
Tuning in to a preset station	12	Playing discs	33
CD OPERATIONS	13	Selecting the playback modes	36
Playing a CD	13	EXTERNAL COMPONENT OPERATIONS ...	37
Locating a track or a particular portion on a CD	14	Playing an external component	37
Selecting CD playback modes	15	TROUBLESHOOTING	38
Playing a CD Text	16	MAINTENANCE	41
Prohibiting disc ejection	16	Handling discs	41
MP3/WMA INTRODUCTION	17	SPECIFICATIONS	42
What are MP3/WMA?	17		
How are MP3/WMA files recorded and played back?	17		

BEFORE USE

*For safety....

- Do not raise the volume level too much, as this will block outside sounds, making driving dangerous.
- Stop the car before performing any complicated operations.

*Temperature inside the car....

If you have parked the car for a long time in hot or cold weather, wait until the temperature in the car becomes normal before operating the unit.



LOCATION OF THE BUTTONS

ENGLISH

Control panel

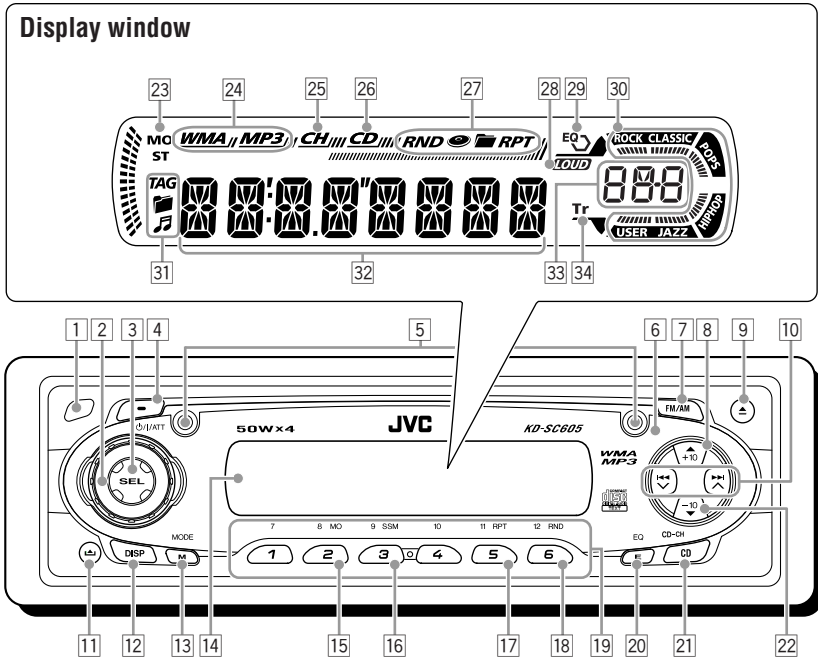

- 1 Remote sensor
- 2 Control dial
- 3 SEL (select) button
- 4 O/I/ATT (standby/on/attenuator) button
- 5 Screw—M2 x 5 mm
- 6 Plate cover and standard plate
- 7 FM/AM button
- 8 ▲ (up) button
+10 button
- 9 ▲ (eject) button
- 10 ◀◀ ▶▶ / ▶▶▶ ▶▶▶ ▲ buttons
- 11 ▶ (control panel release) button
- 12 DISP (display) button
- 13 M MODE button
- 14 Display window
- 15 MO (monaural) button
- 16 SSM (strong-station sequential memory) button
- 17 RPT (repeat) button
- 18 RND (random) button
- 19 Number buttons
- 20 E EQ (equalizer) button
- 21 CD CD-CH (CD changer) button
- 22 ▼ (down) button
-10 button

Display window

- 23 Tuner reception indicators—MO (monaural), ST (stereo)
- 24 Disc type indicators—WMA, MP3
- 25 CH (CD changer) indicator
- 26 CD indicator
- 27 Playback mode/item indicators—RND (random), (disc), (folder), RPT (repeat)
- 28 LOUD (loudness) indicator
- 29 EQ (equalizer) indicator
- 30 Sound mode (C-EQ: custom equalizer) indicators—ROCK, CLASSIC, POPS, HIP HOP, JAZZ, USER
• also works as level meter during play if the level meter is activated (see page 27).
- 31 Disc information indicators—TAG (ID3 Tag), (folder), (track/file)
- 32 Main display
- 33 Source display
Volume level indicator
- 34 Tr (track) indicator



Remote controller

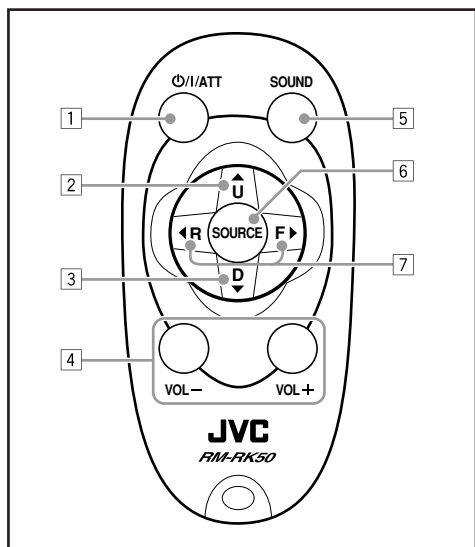

- 1 • Turns on the unit if pressed when the unit is turned off.
 - Turns off the unit if pressed and held until “SEE YOU” appears on the display.
 - Drops the volume level in a moment if pressed briefly.
Press again to resume the volume.
- 2 • Selects the band while listening to the radio. Each time you press the button, the band changes.
 - Skips to the first file of the next folder while listening to an MP3 or a WMA disc. Each time you press the button, you can move to the next folder and start playing the first file.
 - While playing an MP3 disc on an MP3-compatible CD changer;
 - Skips to the next disc if pressed briefly.
 - Skips to the next folder if pressed and held.

Note: While playing a CD on a CD changer, this always skips to the next disc.

- 3 • Selects the preset stations while listening to the radio.
Each time you press the button, the preset station number increases, and the selected station is tuned in.
 - Skips to the first file of the previous folder while listening to an MP3 or a WMA disc. Each time you press the button, you can move to the previous folder and start playing the first file.
 - While playing an MP3 disc on an MP3-compatible CD changer;
 - Skips to the previous disc if pressed briefly.
 - Skips to the previous folder if pressed and held.

Note: While playing a CD on a CD changer, this always skips to the previous disc.
- 4 Functions the same as the control dial on the main unit.

Note: These buttons do not function for the preferred setting mode adjustment.
- 5 Selects the sound mode (C-EQ: custom equalizer).
Each time you press the button, the sound mode (C-EQ) changes.
- 6 Selects the source.
Each time you press the button, the source changes.
- 7 • Searches for stations while listening to the radio.
 - Fast-forwards or reverses the track/file if pressed and held while listening to a disc.
 - Skips to the beginning of the next track/file or goes back to the beginning of the current (or previous) tracks/files if pressed briefly while listening to a disc.



Preparing the remote controller

Before using the remote controller:

- Aim the remote controller directly at the remote sensor on the main unit. Make sure there is no obstacle in between.

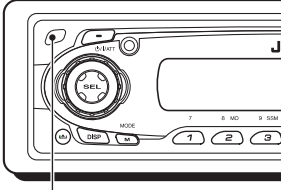

Remote sensor

- Do not expose the remote sensor to strong light (direct sunlight or artificial lighting).

Installing the battery

When the controllable range or effectiveness of the remote controller decreases, replace the battery.

1. Remove the battery holder.

- 1) Push out the battery holder in the direction indicated by the arrow using a ball-point pen or a similar tool.
- 2) Remove the battery holder.

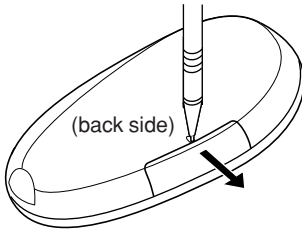

2. Place the battery.

Slide the battery into the holder with the + side facing upwards so that the battery is fixed in the holder.

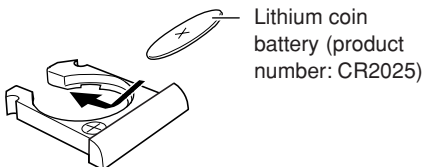

3. Return the battery holder.

Insert again the battery holder by pushing it until you hear a clicking sound.

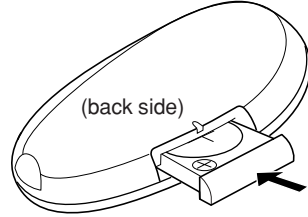

WARNING:

- Store the battery in a place where children cannot reach.
If a child accidentally swallows the battery, consult a doctor immediately.
- Do not recharge, short, disassemble, or heat the battery or dispose of it in a fire.
Doing any of these things may cause the battery to give off heat, crack, or start a fire.
- Do not leave the battery with other metallic materials.
Doing this may cause the battery to give off heat, crack, or start a fire.
- When throwing away or saving the battery, wrap it in tape and insulate; otherwise, the battery may start to give off heat, crack, or start a fire.
- Do not poke the battery with tweezers or similar tools.
Doing this may cause the battery to give off heat, crack, or start a fire.

CAUTION:

DO NOT leave the remote controller in a place (such as dashboards) exposed to direct sunlight for a long time. Otherwise, it may be damaged.

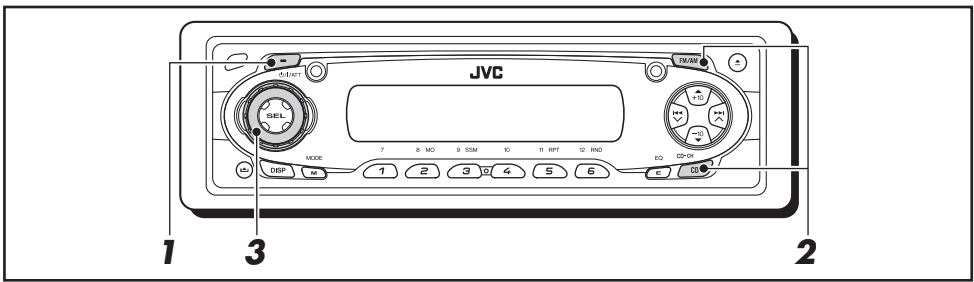

Turning on the power

1 Turn on the power.

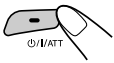

Note on One-Touch Operation:

When you select a source in step 2 below, the power automatically comes on. You do not have to press this button to turn on the power.

2 Select the source.

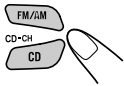

To operate the tuner (FM or AM), see pages 10 – 12

To play a CD, see pages 13 – 16.

To play an MP3/WMA disc, see pages 18 – 22.

To operate the CD changer, see pages 33 – 36.

To operate the external component (LINE IN), see page 37.

3 Adjust the volume.



To increase the volume

To decrease the volume

Volume level indicator

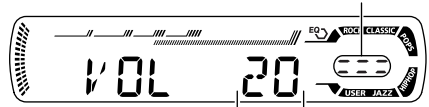

Volume level appears.

4 Adjust the sound as you want. (See pages 23 and 24.)

To drop the volume in a moment

Press **P/ATT** briefly while listening to any source. "ATT" starts flashing on the display, and the volume level will drop in a moment.

To resume the previous volume level, press the button briefly again.

- If you turn the control dial, you can also restore the sound.

To turn off the power

Press and hold **P/ATT** for more than one second.

"SEE YOU" appears, then the unit turns off.

- If you turn off the power while listening to a disc, disc play will start from where playback has been stopped previously, next time you turn on the power.

CAUTION on Volume Setting:

Discs produce very little noise compared with other sources. If the volume level is adjusted for the tuner, for example, the speakers may be damaged by the sudden increase in the output level. Therefore, lower the volume before playing a disc and adjust it as required during playback.

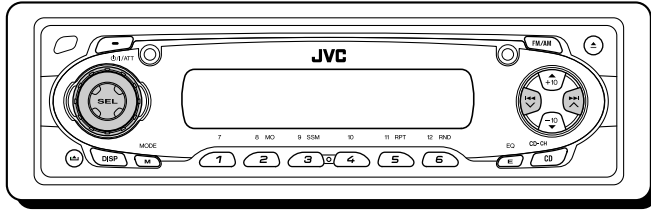

Canceling the display demonstration

When shipped from the factory, display demonstration has been activated, and starts automatically when no operations are done for about 20 seconds.

- It is recommended to cancel the display demonstration before you use the unit for the first time.

To cancel the display demonstration, follow the procedure below:

- 1** Press and hold SEL (select) for more than 2 seconds so that one of the PSM items appears on the display. (PSM: see pages 25 and 26.)



- 2** Select "DEMO" if not shown on the display.

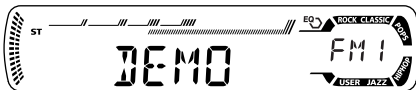
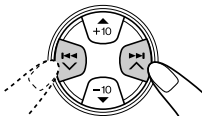

- 3** Select "DEMO OFF."



DEMO OFF ↔ DEMO ON

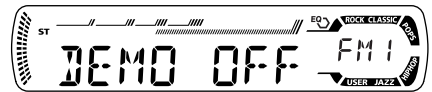

- 4** Finish the setting.



To activate the display demonstration, repeat the same procedure and select "DEMO ON" in step 3.



Setting the clock

1 Press and hold SEL (select) for more than 2 seconds so that one of the PSM item appears on the display. (PSM: see page 25 and 26.)



2 Set the hour.

1 Select "CLOCK H" (hour) if not shown on the display.

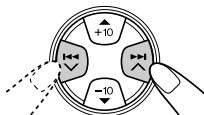

2 Adjust the hour.



3 Set the minute.

1 Select "CLOCK M" (minute).

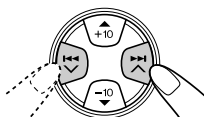

2 Adjust the minute.



4 Finish the setting.



To check the current clock time or change the display mode



Press DISP (display) repeatedly. Each time you press the button, the display changes as follows:

• During tuner operation:



• During disc operation:

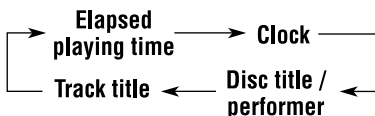

Notes:

- If a name has been assigned to a station, it will be shown instead of "NO NAME".
- While playing a conventional CD, "NO NAME" appears for the disc title/performer and the track title.
- For indication change while playing a CD Text or an MP3/WMA disc, see also pages 16 and 19.

• During external component operation:

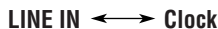

• During power off:

The power turns on and the clock time is shown for 5 seconds, then the power turns off.



RADIO OPERATIONS

ENGLISH

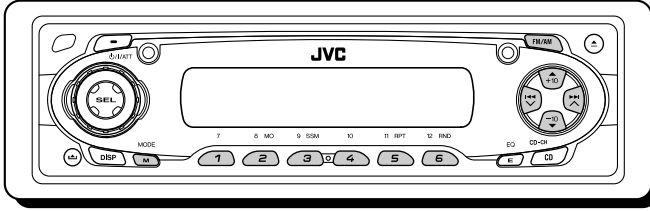

Listening to the radio

You can use either automatic searching or manual searching to tune in to a particular station.

Searching a station automatically:

Auto search

- 1** Select the band (FM1 – 3, AM).



Each time you press the button, the band changes as follows:

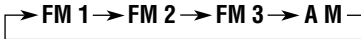

Lights up when receiving an FM stereo broadcast with sufficient signal strength.

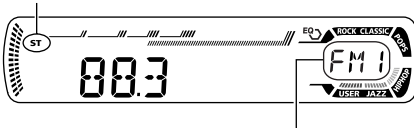

Selected band appears.

Note:

This receiver has three FM bands (FM1, FM2, FM3). You can use any one of them to listen to an FM broadcast.

- 2** Start searching for a station.

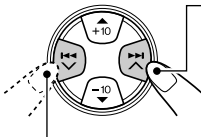

To search stations of higher frequencies

To search stations of lower frequencies

When a station is received, searching stops.

To stop searching before a station is received, press the same button you have pressed for searching.

Searching a station manually:

Manual search

- 1** Select the band (FM1 – 3, AM).



Each time you press the button, the band changes as follows:

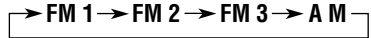

Note:

This receiver has three FM bands (FM1, FM2, FM3). You can use any one of them to listen to an FM broadcast.

- 2** Press and hold **▶▶|▲** or **◀◀|▼** until “M” (manual) starts flashing on the display.

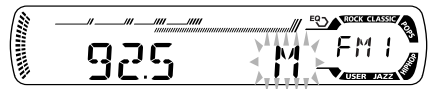
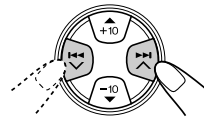

3 Tune in to a station you want while "M" (manual) is flashing.

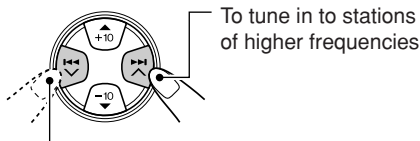

To tune in to stations of lower frequencies

- If you release your finger from the button, the manual mode will automatically turn off after 5 seconds.
- If you hold down the button, the frequency keeps changing (in 50 kHz intervals for FM and 9 kHz for AM) until you release the button.

When an FM stereo broadcast is hard to receive:



- 1 Press M MODE to enter the functions mode while listening to an FM stereo broadcast.

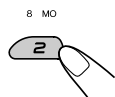

- 2 Press MO (monaural), while "MODE" is still flashing on the display, so that the "MONO" appears on the display. Each time you press the button, monaural mode turns on and off alternately.



MO (monaural) indicator

When the MO indicator is lit on the display, the sound you hear becomes monaural but the reception will be improved.

Storing stations in memory

You can use one of the following two methods to store broadcasting stations in memory.

- Automatic preset of FM stations: (Strong-station Sequential Memory)
- Manual preset of both FM and AM stations

FM station automatic preset: SSM

You can preset 6 local FM stations in each FM band (FM1, FM2, and FM3).

1 Select the FM band (FM1 – 3) you want to store FM stations into.



Each time you press the button, the band changes as follows:

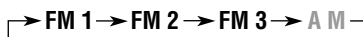

2 Press M MODE to enter the functions mode.



3 Press and hold SSM for about 2 seconds.

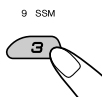

"SSM" appears, then disappears when automatic preset is over.

Local FM stations with the strongest signals are searched and stored automatically in the band number you have selected (FM1, FM2, or FM3). These stations are preset in the number buttons—No.1 (lowest frequency) to No.6 (highest frequency).

When automatic preset is over, the station stored in number button 1 will be automatically tuned in.



Manual preset

You can preset up to 6 stations in each band (FM1, FM2, FM3, and AM) manually.

Ex.: Storing FM station of 92.5 MHz into the preset number 1 of the FM1 band.

1 Select the band (FM1 – 3, AM) you want to store stations into (in this example, FM1).



Each time you press the button, the band changes as follows:

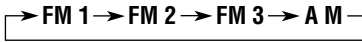

2 Tune in to a station (in this example, of 92.5 MHz).

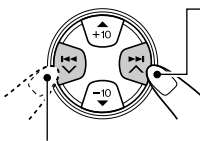

To tune in to stations of higher frequencies

To tune in to stations of lower frequencies

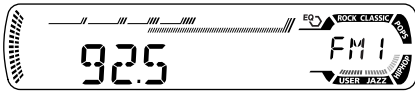

3 Press and hold the number button (in this example, 1) for more than 2 seconds.

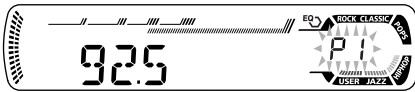
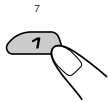

Preset number flashes for a few seconds.

4 Repeat the above procedure to store other stations into other preset numbers.

Notes:

- A previously preset station is erased when a new station is stored in the same preset number.
- Preset stations are erased when the power supply to the memory circuit is interrupted (for example, during battery replacement). If this occurs, preset the stations again.

Tuning in to a preset station

You can easily tune in to a preset station. Remember that you must store stations first. If you have not stored them yet, see “Storing stations in memory” on pages 11 and 12.

1 Select the band (FM1 – 3, AM).



Each time you press the button, the band changes as follows:

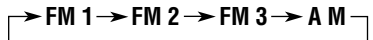

2 Select the number (1 – 6) for the preset station you want.

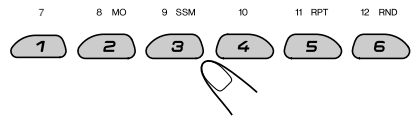

Note:

You can also use the ▲ (up) or ▼ (down) button on the unit to select the next or previous preset stations. Each time you press the ▲ (up) or ▼ (down) button, the next or previous preset station is tuned in.

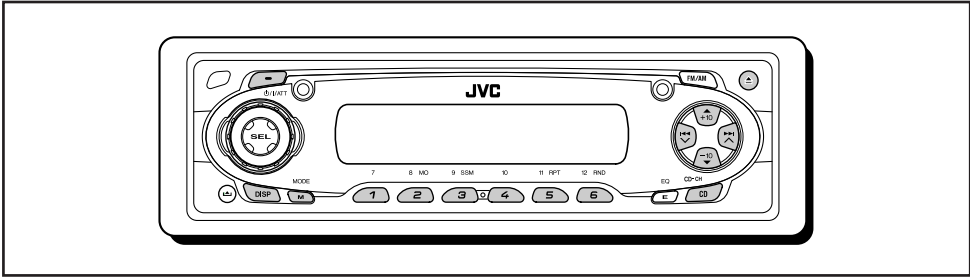

Refer to "MP3/WMA OPERATIONS" on pages 18 to 22 for operating MP3/WMA discs.

The display changes to show the following:

Playing a CD

1 Open the control panel.

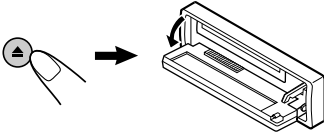

Note:
When a CD is already in the loading slot, pressing CD-CH turns on the unit and starts playback automatically.

2 Insert a CD into the loading slot.

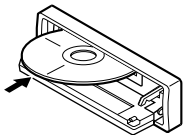

The unit turns on, draws the CD and starts playback automatically.

3 Close the control panel by hand.

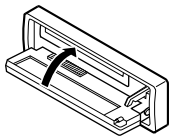

All tracks will be played repeatedly until you stop playback.

CD indicator Current source indication

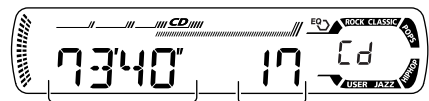
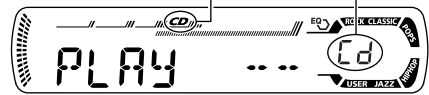

Total playing time of the inserted disc Total track number of the inserted disc

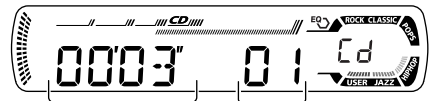

Elapsed playing time Current track

Notes:

- When a CD is inserted upside down, the CD automatically ejects (if the control panel is open). If the control panel is closed, the source changes to the previously selected source, "PLEASE" and "EJECT" appear alternately on the display.
- If there is no CD in the loading slot, you cannot select CD as the source. "NO DISC" appears on the display.
- If a disc is a CD Text, disc title/performer and then track title will automatically appear.



To stop play and eject the CD

Press **▲**.
CD play stops and the control panel flips down. The CD automatically ejects from the loading slot. The source changes to the previously selected source.

- If you change the source, CD play also stops (without ejecting the CD).
Next time you select “CD” as the source, CD play starts from where playback has been stopped previously.

Notes:

- If the ejected disc is not removed for about 15 seconds, the disc is automatically inserted again into the loading slot to protect it from dust. (Disc play will not start this time.)
- You can eject the disc even when the unit is turned off.

Locating a track or a particular portion on a CD

To fast-forward or reverse the track

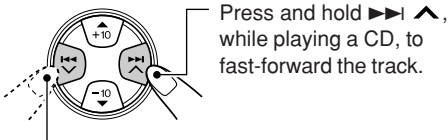

Press and hold <<<▼, while playing a CD, to reverse the track.

To go to the next or previous tracks

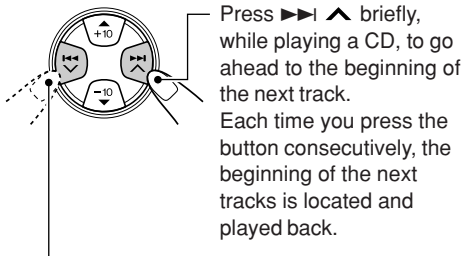

Press <<<▼ briefly, while playing a CD, to go back to the beginning of the current track. Each time you press the button consecutively, the beginning of the previous tracks is located and played back.

To go to a particular track directly

Press the number button corresponding to the track number to start its playback.

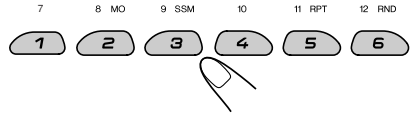

- To select a track number from 1 – 6:
Press 1 (7) – 6 (12) briefly.
- To select a track number from 7 – 12:
Press and hold 1 (7) – 6 (12) for more than one second.

To go to a track quickly (+10 and -10 buttons)

- 1 Press M MODE to enter the functions mode while playing a CD.



- 2 Press +10 or -10.

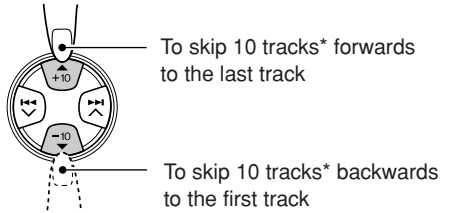

- * The first time you press +10 or -10 button, the track skips to the nearest higher or lower track with a track number of multiple ten (ex. 10th, 20th, 30th).

Then, each time you press the button, you can skip 10 tracks (see “How to use the +10 and -10 buttons” on page 15).

- After the last track, the first track will be selected, and vice versa.



How to use the +10 and -10 buttons

- Ex. 1: To select track number 32 while playing track number 6

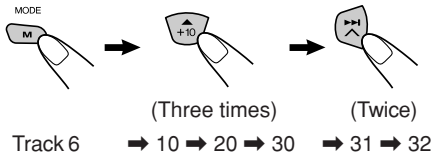

- Ex. 2: To select track number 8 while playing track number 36

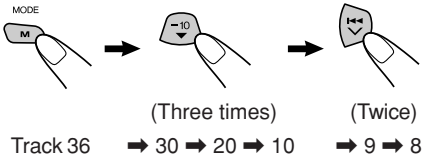

To play back tracks repeatedly (Track Repeat Play)

You can play back the current track repeatedly.

- 1 Press M MODE to enter the functions mode while playing a CD.



- 2 Press RPT (repeat), while "MODE" is still flashing on the display, so that "TRK RPT" appears on the display.

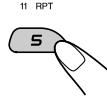

Each time you press the button, track repeat play mode turns on and off alternately.

RPT indicator

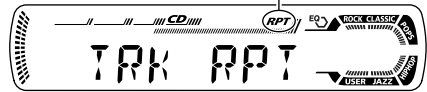

Selecting CD playback modes

To play back tracks at random (Disc Random Play)

You can play back all tracks on the CD at random.

- 1 Press M MODE to enter the functions mode while playing a CD.



- 2 Press RND (random), while "MODE" is still flashing on the display, so that "DISC RND" appears on the display.

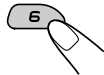

Each time you press the button, disc random play mode turns on and off alternately.

RND and (disc) indicators

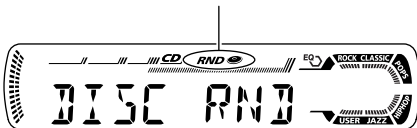

When disc random play is turned on, the RND and (disc) indicators light up on the display. A track randomly selected starts playing.



Playing a CD Text

In a CD Text, some information about the disc (its disc title, performer, and track title) is recorded. This CD Text information will be shown automatically when you play a CD Text.

To change the CD Text information manually, select text display mode while playing a CD Text.

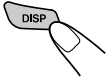

Press DISP (display) repeatedly. Each time you press the button, the display changes as follows:

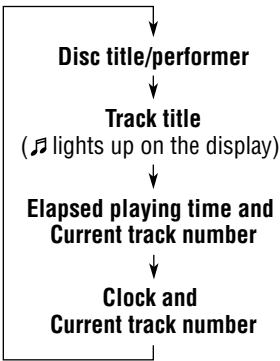

Notes:

- The display shows up to 8 characters at one time and scrolls if there are more than 8 characters. See also “To select the scroll mode—SCROLL” on page 28.
Some characters or symbols will not be shown (and will be blanked) on the display.
(Ex. “ABC&!d#” ⇨ “ABCA D ”)
- When you press DISP (display) while playing a conventional CD, “NO NAME” appears for the disc title/performer and the track title.
- When track title is shown, the **Tr** indicator and current track number also appear on the right side of the display.

Prohibiting disc ejection

You can prohibit disc ejection and can lock a disc in the loading slot.

While pressing CD, press and hold /I/ATT for more than 2 seconds.

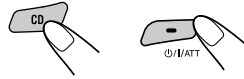

“NO EJECT” flashes on the display for about 5 seconds, and the disc is locked and cannot be ejected.



To cancel the prohibition and unlock the disc

While pressing CD, press and hold /I/ATT again for more than 2 seconds.

“EJECT OK” flashes on the display for about 5 seconds, and the disc is unlocked.

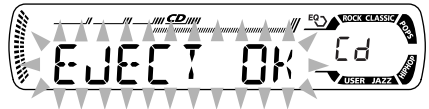

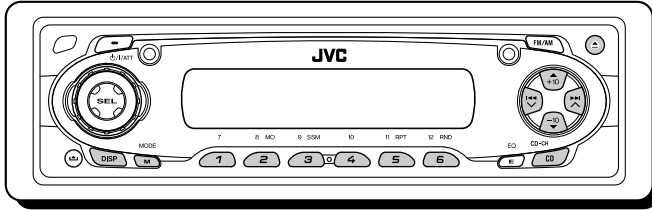

Refer also to "CD OPERATIONS" on pages 13 to 16.

The display changes to show the following:

Playing a disc

1 Open the control panel.

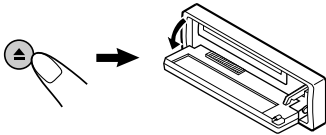

Note on One-Touch Operation:

When a disc is already in the loading slot, pressing CD CD-CH turns on the unit and starts playback automatically.

2 Insert a disc into the loading slot.

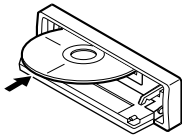

The unit turns on, draws the disc and starts playback automatically.

3 Close the control panel by hand.

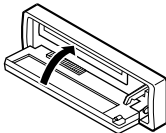

All files will be played repeatedly until you stop playback.

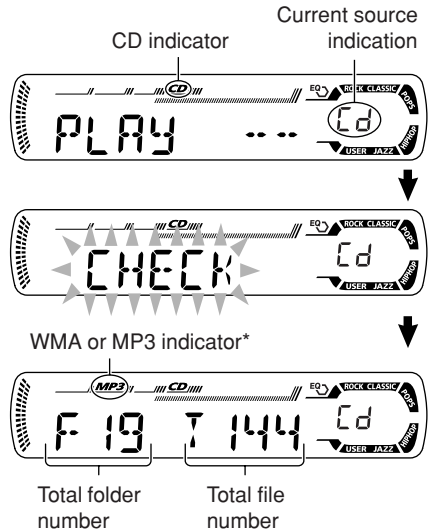

Ex.: When the disc contains 19 folders and 144 MP3/WMA files

* WMA or MP3 indicator lights up depending on the first detected file.

Notes:

- MP3/WMA discs require a longer readout time. (It differs due to the complexity of the folder/file configuration.)
- When playback starts, folder and file names (or ID3 tags) will automatically appears. (See also page 19.)
- If you change the source or turn the power off, disc playback stops (without ejecting the disc). Next time you select the CD player as the source or turn the power on, disc play starts from where playback has been stopped previously.

To stop play and eject the disc

Press .
Playback stops and the control panel flips down.
The disc automatically ejects from the loading slot.

To change the display information

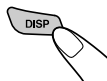

While playing back an MP3/WMA file, you can change the disc information shown on the display.
Press DISP (display) repeatedly.
Each time you press the button, the display changes to show the following:

- When “TAG DISP” is set to “TAG ON” (initial setting: see page 28)

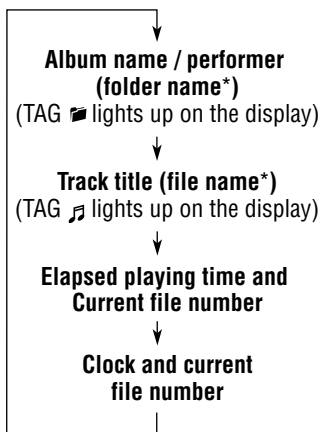

* If ID3 tags are not recorded, folder name and file name appear. In this case, the TAG indicator will not light up on the display.

- When “TAG DISP” is set to “TAG OFF”

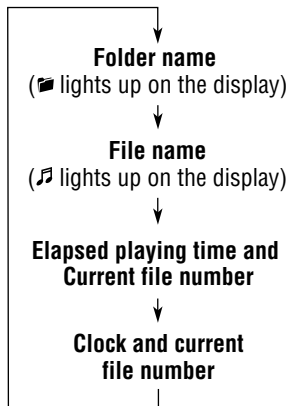



Note:

- The display shows up to 8 characters at a time and scrolls if there are more than 8 characters. See also “To select the scroll mode—SCROLL” on page 28.
- When folder or file name is shown, current folder number or the  indicator and current file number also appear on the right side of the display.

Locating a file or a particular portion on a disc

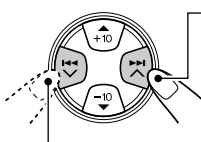
To fast-forward or reverse the file



Press and hold   while playing a disc, to fast-forward the file.



Press and hold   while playing a disc, to reverse the file.

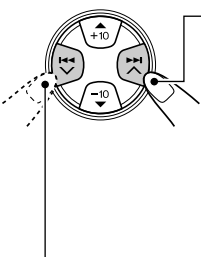

Note:

During this operation, you can only hear intermittent sounds. (The elapsed playing time also changes intermittently on the display.)

To skip to the next or previous files



Press   briefly while playing, to skip ahead to the beginning of the next file.
Each time you press the button consecutively, the beginning of the next files is located and played back.

Press   briefly while playing, to skip back to the beginning of the current file.
Each time you press the button consecutively, the beginning of the previous files is located and played back.

To go to a particular file quickly within the current folder (+10 and -10 buttons)

- 1 Press M MODE to enter the functions mode while playing a disc.



- 2 Press +10 or -10.

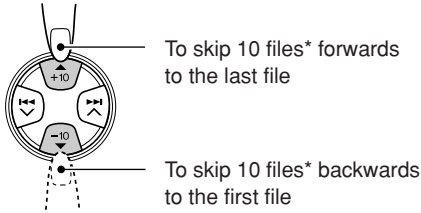

- * The first time you press +10 or -10 button, the file skips to the nearest higher or lower file with a file number of multiple ten (ex. 10th, 20th, 30th).

Then, each time you press the button, you can skip 10 files (see "How to use the +10 and -10 buttons" below).

- After the last file, the first file will be selected, and vice versa.

How to use the +10 and -10 buttons

- Ex. 1: To select file number 32 while playing file number 6

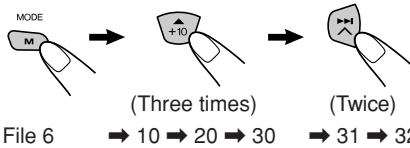

- Ex. 2: To select file number 8 while playing file number 36

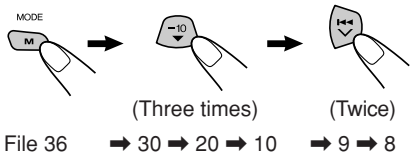

To go to a particular folder directly

IMPORTANT:

To directly select the folders using the number button(s), it is required that folders are assigned 2 digit numbers at the beginning of their folder names. (This can only be done during the recording of CD-Rs or CD-RWs.)

Ex.: If folder name is "01 ABC"

→ Press 1 to go to Folder 01 ABC.

If folder name is "1 ABC," pressing 1 does not work.

If folder name is "12 ABC"

→ Press and hold 6 (12) to go to Folder 12 ABC.

Press the number button corresponding to the folder number to start playing the first file in the selected folder.

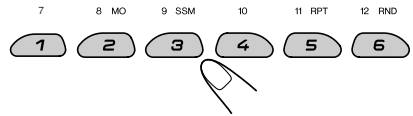

- To select a folder number from 01 – 06: Press 1 (7) – 6 (12) briefly.
- To select a folder number from 07 – 12: Press and hold 1 (7) – 6 (12) for more than one second.

Notes:

- If indicator flashes on the display after you have selected a folder, it means that the folder does not contain any MP3/WMA files.
- You cannot directly select a folder with a number greater than 12.

To select a particular file in a folder, press

▶▶| ▲ or |◀◀ ▼ after selecting the folder.

To skip to the next or previous folder

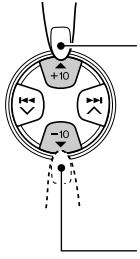

Press ▲ (up) while playing a disc to skip to the next folder. Each time you press the button consecutively, the next folder is located (and the first file in the folder starts playing, if recorded).

Press ▼ (down) while playing a disc to skip back to the previous folder. Each time you press the button consecutively, the previous folder is located (and the first file in the folder starts playing, if recorded).

Note:

If the folder does not contain any MP3/WMA files, it is skipped.

Selecting playback modes

To play back files at random (Folder Random/Disc Random Play)

You can play back all files of the current folder or all files on the disc at random.



1 Press M MODE to enter the functions mode while playing a disc.





2 Press RND (random), while "MODE" is still flashing on the display, so that "FLDR RND" or "DISC RND" appears on the display. Each time you press the button, the random play mode changes as follows:

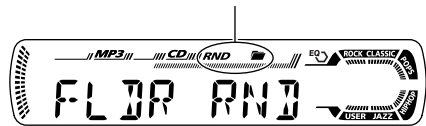

RND and  (folder) indicators



Ex.: When you select "FLDR RND" while listening to an MP3 file

Mode	Active indicator	Plays at random
FLDR RND	RND and  indicators light up.	All files of the current folder, then files of the next folder and so on.
DISC RND	RND and  indicators light up.	All files on the disc.

To play back files repeatedly (Track Repeat/Folder Repeat Play)

You can play back the current file or all the files in the current folder repeatedly.



- 1 Press M MODE to enter the functions mode while playing a disc.

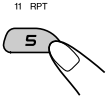

- 2 Press RPT (repeat), while "MODE" is still flashing on the display, so that "TRK RPT" or "FLDR RPT" appears on the display. Each time you press the button, repeat play mode changes as follows:



RPT indicator

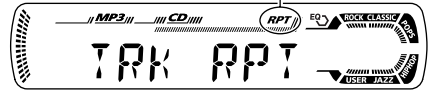

Ex.: When you select "TRK RPT" while listening to an MP3 file

Mode	Active indicator	Plays repeatedly
TRK RPT	RPT indicator lights up.	The current (or specified) file.
FLDR RPT	RPT and  indicators light up.	All files of the current (or specified) folder.



Selecting preset sound modes (C-EQ: custom equalizer)

You can select a preset sound mode (C-EQ: custom equalizer) suitable to the music genre.

Select the sound mode you want.



Each time you press the button, the sound modes change as follows:

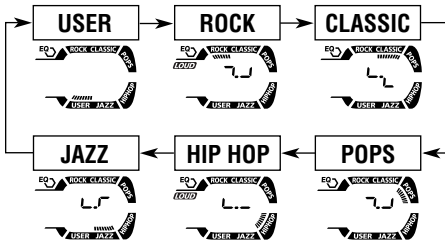

Indication pattern changes for each sound mode except for "USER"

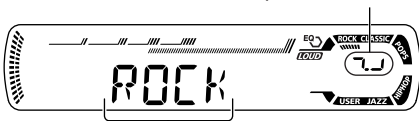

Ex.: When you select "ROCK"

Indication	For:	Preset values		
		BAS	TRE	LOUD
USER	(Flat sound)	00	00	OFF
ROCK	Rock or disco music	+03	+01	ON
CLASSIC	Classical music	+01	-02	OFF
POPS	Light music	+04	+01	OFF
HIP HOP	Funk or rap music	+02	00	ON
JAZZ	Jazz music	+02	+03	OFF

Note:

You can adjust each sound mode to your preference. Once you make an adjustment, it is automatically stored for the currently selected sound mode. See "Adjusting the sound" on page 24.



Adjusting the sound

You can adjust the sound characteristics to your preference.

1 Select the item you want to adjust.



Each time you press the button, the adjustable items change as follows:

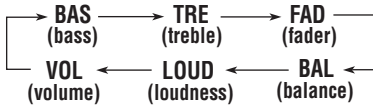

Indication	To do:	Range
BAS* ¹	Adjust the bass.	-06 (min.) +06 (max.)
TRE* ¹	Adjust the treble.	-06 (min.) +06 (max.)
FAD* ²	Adjust the front and rear speaker balance.	R06 (Rear only) F06 (Front only)
BAL	Adjust the left and right speaker balance.	L06 (Left only) R06 (Right only)
LOUD* ¹	Boost low and high frequencies to produce a well-balanced sound at low volume level.	LOUD ON LOUD OFF
VOL* ³	Adjust the volume.	00 (min.) 30 or 50 (max.) ^{*4}

*¹ When you adjust the bass, treble, or loudness, the adjustment you have made is stored for the currently selected sound mode (C-EQ) including "USER."

*² If you are using a two-speaker system, set the fader level to "00."

*³ Normally the control dial works as the volume control. So you do not have to select "VOL" to adjust the volume level.

*⁴ Depending on the amplifier gain control. (See page 28 for details.)

2 Adjust the setting.



To increase the level or turn on the loudness

To decrease the level or turn off the loudness

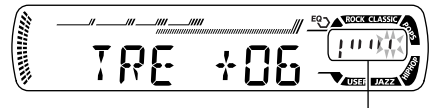

Indication pattern changes as you adjust the bass or treble.

Ex. 1: When you adjust "TRE" (treble)

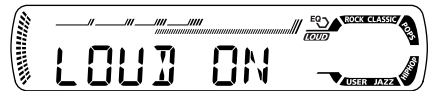

Ex. 2: When you turn on the loudness

3 Repeat steps 1 and 2 to adjust the other items.

To reset each sound mode to the factory settings, repeat the same procedure and reassign the preset values listed in the table on page 23.

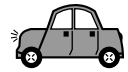

Changing the general settings (PSM)

You can change the items listed on the next page by using the PSM (Preferred Setting Mode) control.

Basic Procedure

1 Press and hold SEL (select) for more than 2 seconds so that one of the PSM items appears on the display. (See page 26.)



2 Select the PSM item you want to adjust. (See page 26.)

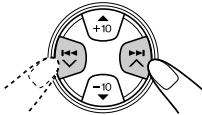

3 Adjust the PSM item selected.

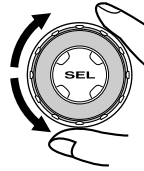

4 Repeat steps 2 and 3 to adjust the other PSM items if necessary.



5 Finish the setting.



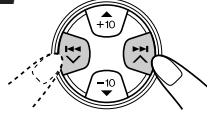

Preferred Setting Mode (PSM) items

• For detailed operations of each PSM items, refer to the pages listed in the table.

1	2	3			
				Factory-preset settings	See page
Hold...	Select...	Set... Counter-clockwise	Clockwise		
DEMO	Display demonstration	DEMO OFF	DEMO ON	DEMO ON	8
CLOCK H	Hour adjustment	Back	Advance	1 (1:00)	9
CLOCK M	Minute adjustment	Back	Advance	00 (1:00)	9
COLOR	Color adjustment	(See page 27)		ALL DEMO	27
LEVEL	Level display	OFF	ON	ON	27
DIMMER	Dimmer mode	AUTO ↙	↔ ON	OFF ↘	AUTO
SCROLL	Scroll mode	ONCE ↙	↔ OFF	AUTO ↘	ONCE
EXT IN*	External component	CHANGER	LINE IN	CHANGER	28
TAG DISP	Tag display	TAG OFF	TAG ON	TAG ON	28
AMP GAIN	Amplifier gain control	LOW PWR	HIGH PWR	HIGH PWR	28

• Press SEL (select) to finish the setting.

* Displayed only when one of the following sources is selected—FM, AM, and CD.



To select the display color—COLOR

You can select the color of the display according to your preference.

When shipped from the factory, "ALL DEMO" is selected.

The selectable colors are as follows:

ALL DEMO ⇄ SOURCE ⇄ BLUE ⇄ OCEAN ⇄ PURPLE ⇄ PINK ⇄ ROSE ⇄ RED ⇄ (back to the beginning)

- **ALL DEMO:** The display color changes every 6 seconds (rose → pink → ocean → red → purple → blue → back to the beginning).
- **SOURCE:** The display color is fixed to red while listening to FM or AM, blue while listening to CD, and purple while listening to external component.

To select the level meter—LEVEL

You can activate or deactivate the level meter according to your preference.

When shipped from the factory, level meter is activated.

- **ON:** Shows the audio level indicator.
- **OFF:** Cancels the audio level indicator; sound mode indicator is shown.

To select the dimmer mode—DIMMER

When you turn on the car head lights, the display automatically dims (Auto Dimmer).

When shipped from the factory, Auto Dimmer mode is activated.

- **AUTO:** Activates Auto Dimmer.
- **OFF:** Cancels Auto Dimmer.
- **ON:** Always dims the display.

Note:

Auto Dimmer equipped with this unit may not work correctly on some vehicles, particularly on those having a control dial for dimming.

In this case, set the dimmer mode to "ON" or "OFF."



To select the scroll mode—SCROLL

You can select the scroll mode for the disc information (when the entire text cannot be shown all at once).

When shipped from the factory, scroll mode is set to "ONCE."

- ONCE: Scrolls only once.
- AUTO: Repeats the scroll (5-second intervals in between).
- OFF: Cancels scroll mode.

Note:

Even if the scroll mode is set to "OFF," you can scroll the display by pressing DISP (display) for more than one second.

To select the external component to use—EXT IN

You can connect the external component to the CD changer jack on the rear using the Line Input Adapter KS-U57 (not supplied).

To use the external component as the playback source through this unit, you need to select which component—CD changer or external component—to use.

When shipped from the factory, CD changer is selected as the external component.

- CHANGER: To use the CD changer.
- LINE IN: To use the external component other than CD changer.

Note:

For connecting the Line Input Adapter KS-U57 and the external component, refer to the Installation/Connection Manual (separate volume).

To turn the tag display on or off—TAG DISP

An MP3/WMA file can contain file information called "ID3 Tag" where its album name, performer, track title, etc. are recorded.

There are two versions—ID3v1 (ID3 Tag version 1) and ID3v2 (ID3 Tag version 2). If both ID3v1 and ID3v2 are recorded on a disc, ID3v2 information will be shown.

When shipped from the factory, "TAG ON" is selected.

- TAG ON: Turns on the ID3 tag display while playing MP3/WMA files.
 - If an MP3/WMA file does not have ID3 tags, folder name and file name appear.
- TAG OFF: Turns off the ID3 tag display while playing MP3/WMA files. (Only the folder name and file name can be shown.)

To select the amplifier gain control—AMP GAIN

You can change the maximum volume level of this unit. When the maximum power of the speakers is less than 50 W, select "LOW PWR" to prevent them from being damaged.

When shipped from the factory, "HIGH PWR" is selected.

- LOW PWR: You can adjust the volume level from "VOL 00" to "VOL 30."

Note:

If you change the initial setting from "HIGH PWR" to "LOW PWR" while listening at a volume level more than 30, the unit automatically changes the volume level to "VOL 30."

- HIGH PWR: You can adjust the volume level from "VOL 00" to "VOL 50."



Assigning names to the sources

You can assign names to station frequencies and CDs (both in this unit and in the CD changer). After assigning a name, it will appear on the display when you select the source.

Sources	Maximum number of characters
Station frequencies	Up to 8 characters (up to 30 station frequencies including both FM and AM)
CDs*	Up to 32 characters (up to 40 discs)

* You cannot assign a name to CD Text or an MP3/WMA disc.

1 Select a source you want to assign a name to.

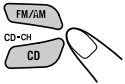

When you select a source, the power automatically comes on.

2 While pressing DISP (display), press and hold SEL (select) for more than 2 seconds.

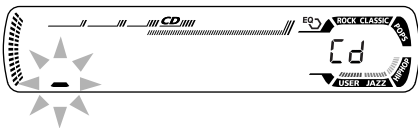
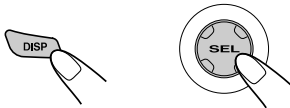

Ex.: When you select CD as the source

3 Select a character.



• See right column for available characters.

4 Move the cursor to the next (or previous) character position.

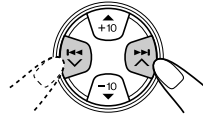

5 Repeat steps 3 and 4 until you finish entering the name.

6 Finish the procedure while the last selected character is flashing.



To erase the input characters

To erase all the characters at a time, press and hold DISP (display) for more than 1 second as described in the procedure above.

Available characters

A	B	C	D	E	F	G	H	I	J
K	L	M	N	O	P	Q	R	S	T
U	V	W	X	Y	Z	0	1	2	3
4	5	6	7	8	9	-	/	<	>
space									

Notes:

- When you try to assign a name to the 41st disc, "NAME FULL" appears on the display. (In this case, delete unwanted names before assignment.)
- When the CD changer is connected, you can assign names to CDs in the CD changer. These names can also be shown on the display if you insert the CDs in this unit.



Changing the standard plate

You can change the standard plate with another plate supplied with your unit.

You can also download them by visiting

<<http://www.jvc.co.jp/jvccar>>.

- When changing the plate, be careful not to leave your fingerprints on the plate or cover.

1 Loosen the screws with the supplied hex screwdriver.

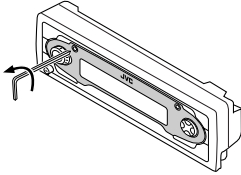

2 Remove the plate cover and the standard plate.

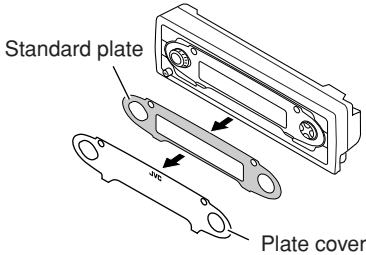

3 Replace with another plate (a standard, cutout, or downloaded plate) of your preference.

- When attaching a standard plate

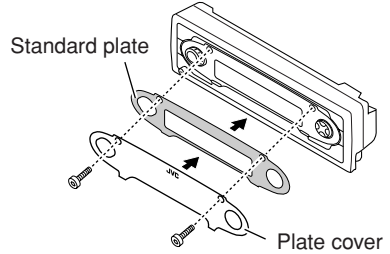

- When attaching a cutout or downloaded plate

Add the transparent plate (supplied) between the cutout or downloaded plate and the plate cover in order to attach the plate cover in place.

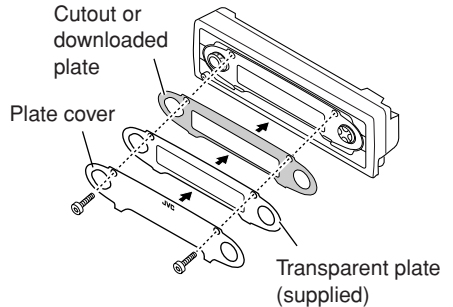



When attaching the plate cover

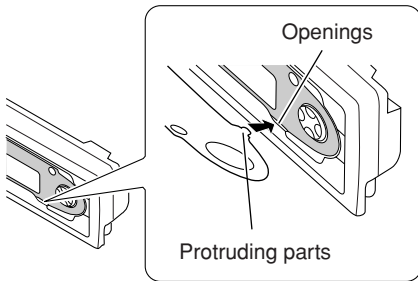

Ensure the two protruding parts at the bottom of the plate cover are inserted into the two openings on the control panel, as illustrated.

Notes:

- Be sure to keep the hex screwdriver for future use.
- Two spare screws for the plate cover attachment are provided with the unit. See the *Installation/Connection Manual* (separate volume).
- When you attach the plate cover, do not tighten the screws too hard; otherwise, the plate cover might be cracked.

How to use the cutout plates

1 Unfold the supplied cutout plates.

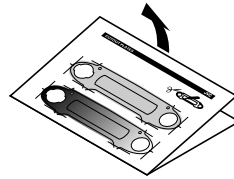

2 Cut the plates out using a scissors.

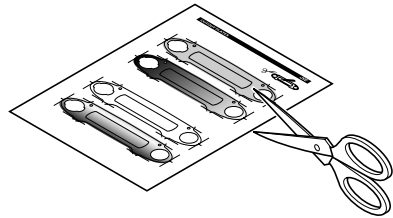

3 Trim out the window and two knobs using a knife on a rubber mat.

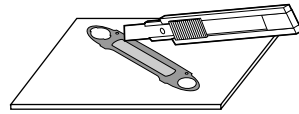



Detaching the control panel

You can detach the control panel when leaving the car.

When detaching or attaching the control panel, be careful not to damage the connectors on the back of the control panel and on the panel holder.

Detaching the control panel

Before detaching the control panel, be sure to turn off the power.

- 1** Unlock the control panel.

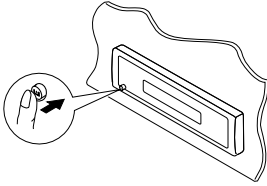

- 2** Pull the control panel out of the unit.

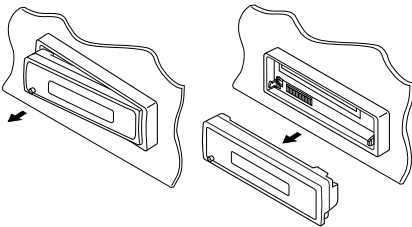

- 3** Put the detached control panel into the provided case.

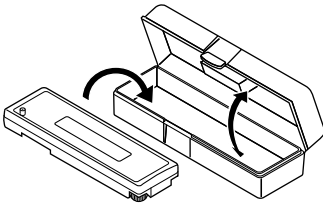

Attaching the control panel

- 1** Insert the right side of the control panel into the groove on the panel holder.

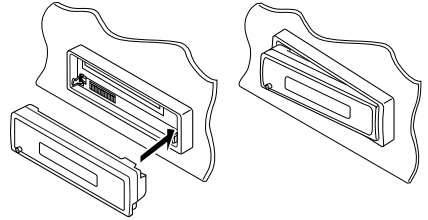

- 2** Press the left side of the control panel to fix it to the panel holder.

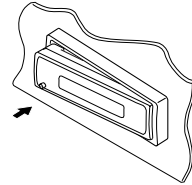

Note on cleaning the connectors:

If you frequently detach the control panel, the connectors will deteriorate.

To minimize this possibility, periodically wipe the connectors with a cotton swab or cloth moistened with alcohol, being careful not to damage the connectors.

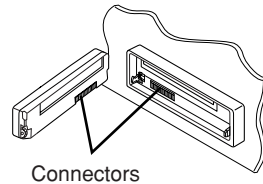

CD CHANGER OPERATIONS

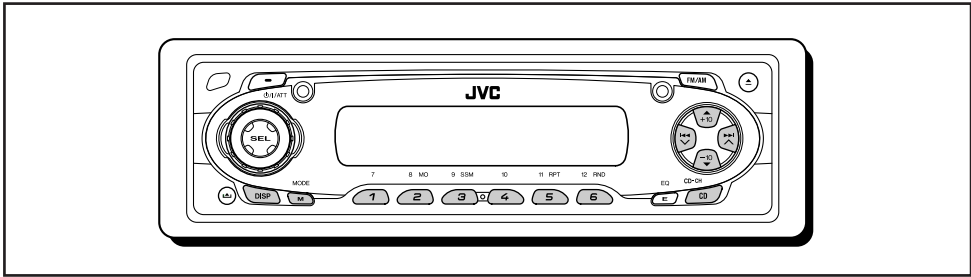

We recommend that you use the JVC MP3-compatible CD changer with your unit.

By using this CD changer, you can play back your original CD-Rs (Recordable) and CD-RWs (Rewritable) recorded either in audio CD format or in MP3 format.

- You can also connect other CH-X series CD changers (except CH-X99 and CH-X100). However, they are not compatible with MP3 discs, so you cannot play back MP3 discs.
- You cannot use the KD-MK series CD changers with this unit.

Before operating your CD changer:

- Refer also to the Instructions supplied with your CD changer.
- If no discs are in the magazine of the CD changer or the discs are inserted upside down, “NO DISC” will appear on the display. If this happens, remove the magazine and set the discs correctly.
- If no magazine is loaded in the CD changer, “NO MAG” appears on the display. If this happens, insert the magazine in the CD changer.
- If “RESET 1” – “RESET 8” appears on the display, something is wrong with the connection between this unit and the CD changer. If this happens, check the connection and make sure the cords are connected firmly. Then, press the reset button of the CD changer.

Note:

You cannot control and play any WMA disc on the CD changer.

Playing discs

Select the CD changer (CD-CH).



* If you have changed “EXT IN” setting to “LINE IN” (see page 28), you cannot select the CD changer.

- **When the current disc is an MP3 disc:** Playback starts from the first folder of the current disc once file check is completed.

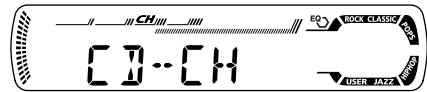

Selected disc number ↓



MP3 indicator ↓

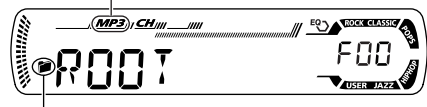

■ (folder) indicator

Note:

Folder name appears on the display instead of “ROOT,” if an MP3 disc contains a folder.

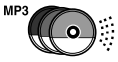

- **When the current disc is a CD:**
Playback starts from the first track of the current disc.

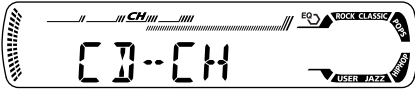

Selected disc number ↓

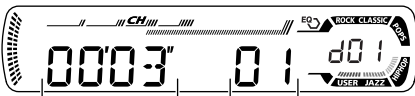
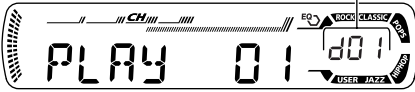

Elapsed playing time Current track

Notes:

- When you press CD CD-CH, the power automatically comes on. You do not have to press **⏻/ATT** to turn on the power.
- If you change the source, CD changer play also stops. Next time you select the CD changer as the source, CD changer play starts from where playback has been stopped previously.
- When you start playing back a CD Text or MP3 disc, disc information will automatically appear on the display. (See pages 16 and 19.)

To go to a particular disc directly

Press the number button corresponding to the disc number to start its playback (while the CD changer is playing).

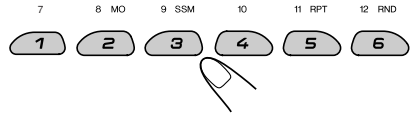

- To select a disc number from 1 – 6:
Press 1 (7) – 6 (12) briefly.
- To select a disc number from 7 – 12:
Press and hold 1 (7) – 6 (12) for more than one second.

To fast-forward or reverse the track/file

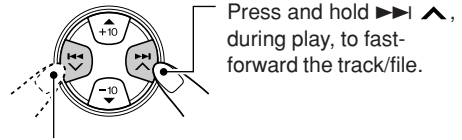

Press and hold **▶▶|▲**, during play, to fast-forward the track/file.

Press and hold **◀◀|▼**, during play, to reverse the track/file.

Note:

During this operation, you can only hear intermittent sounds. (The elapsed playing time also changes intermittently on the display.)

To go to the next or previous tracks/files

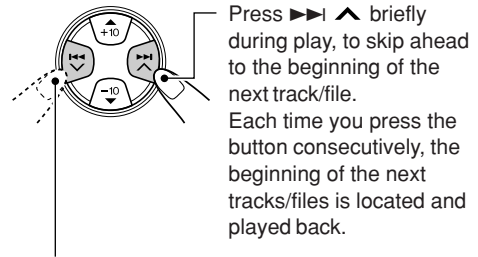

Press **▶▶|▲** briefly during play, to skip ahead to the beginning of the next track/file. Each time you press the button consecutively, the beginning of the next tracks/files is located and played back.

Press **◀◀|▼** briefly during play, to skip back to the beginning of the current track/file. Each time you press the button consecutively, the beginning of the previous tracks/files is located and played back.

This operation is only possible when using JVC MP3-compatible CD changer (CH-X1500).

To go to a track/file quickly (+10 and -10 buttons)

- 1 Press M MODE to enter the functions mode while playing a disc.



- 2 Press +10 or -10.

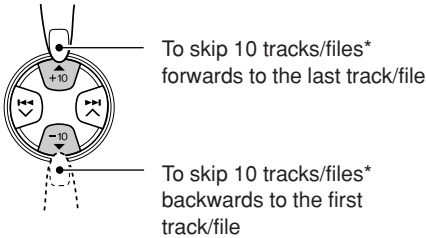

* The first time you press +10 or -10 button, the track/file skips to the nearest higher or lower track/file with a track/file number of multiple ten (ex. 10th, 20th, 30th).

Then, each time you press the button, you can skip 10 tracks/files (see "How to use the +10 and -10 buttons" below).

- After the last track/file, the first track/file will be selected, and vice versa.

Note:

If the current playing disc is an MP3 disc, files are skipped within the same folder.

To skip to the next or previous folder (only for MP3 discs)

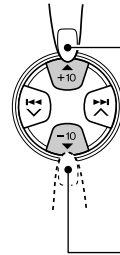

Press ▲ (up) while playing an MP3 disc, to go to the next folder. Each time you press the button consecutively, the next folder is located, and the first file in the folder starts playback.

Press ▼ (down) while playing an MP3 disc, to go to the previous folder. Each time you press the button consecutively, the previous folder is located, and the first file in the folder starts playback.

To show the disc information for CD Text and MP3 discs

This is possible only when connecting a JVC CD changer equipped with CD Text and/or MP3 disc information reading capability.

Select text display mode while playing a CD Text or an MP3 disc.

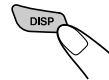

- For details, see page 16 about CD Text disc information and page 19 about MP3 disc information.

How to use the +10 and -10 buttons

- Ex. 1: To select track/file number 32 while playing track/file number 6

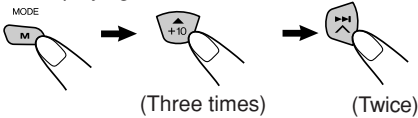

Track/file 6 → 10 → 20 → 30 → 31 → 32

- Ex. 2: To select track/file number 8 while playing track/file number 36



Track/file 36 → 30 → 20 → 10 → 9 → 8



Selecting the playback modes

To play back tracks/files at random (Folder Random/Disc Random/Magazine Random Play)



1 Press M MODE to enter the functions mode during play.



2 Press RND (random), while "MODE" is still flashing on the display. Each time you press the button, random play mode changes as follows:

For MP3 discs:

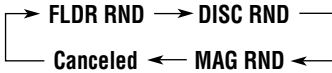

For CDs:

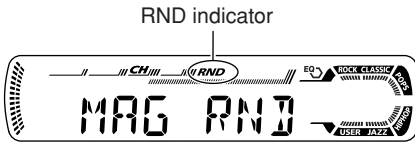

Ex.: When you select "MAG RND"

Note:

MP3 indicator also lights up if the current playing disc is an MP3 disc.

Mode	Active indicator	Plays at random
FLDR RND*	RND and indicators light up.	All files of the current folder, then files of the next folder and so on.
DISC RND	RND and indicators light up.	All tracks/files of the current (or specified) disc.
MAG RND	RND indicator lights up.	All tracks/files of the inserted discs.

* "FLDR RND" is only applicable for MP3 disc.

To play back tracks/files repeatedly (Track Repeat/Folder Repeat/Disc Repeat Play)



1 Press M MODE to enter the functions mode during play.

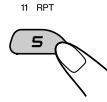

2 Press RPT (repeat), while "MODE" is still flashing on the display. Each time you press the button, the repeat play mode changes as follows:

For MP3 discs:

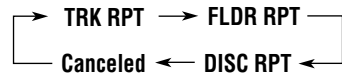

For CDs:



RPT and (disc) indicators

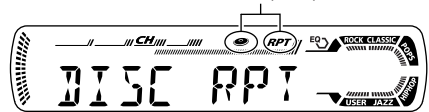

Ex.: When you select "DISC RPT"

Note:

MP3 indicator also lights up if the current playing disc is an MP3 disc.

Mode	Active indicator	Plays repeatedly
TRK RPT	RPT indicator lights up.	The current (or specified) track/file.
FLDR RPT*	RPT and indicators light up.	All files of the current (or specified) folder of the current disc.
DISC RPT	RPT and indicators light up.	All tracks/files of the current (or specified) disc.

* "FLDR RPT" is only applicable for MP3 disc.

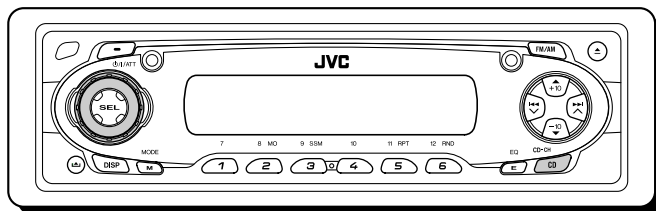

Playing an external component

You can connect the external component to the CD changer jack on the rear using the Line Input Adapter KS-U57 (not supplied).

Preparations:

- For connecting the Line Input Adapter KS-U57 and the external component, refer to the Installation/Connection Manual (separate volume).
- Before operating the external component using the following procedure, select the external input correctly. See "To select the external component to use—EXT IN" on page 28.

1 Select the external component (LINE IN).

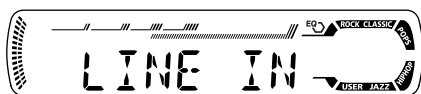

- If "LINE IN"* does not appear on the display, see page 28 and select the external input ("LINE IN").
- * Displayed only when one of the following sources is selected—FM, AM, and CD.

Note on One-Touch Operation:

When you press CD CD-CH, the power automatically comes on. You do not have to press /I/ATT to turn on the power.

2 Turn on the connected component and start playing the source.

3 Adjust the volume.



4 Adjust the sound characteristics you want. (See pages 23 and 24.)



TROUBLESHOOTING

What appears to be trouble is not always serious. Check the following points before calling a service center.

	Symptoms	Causes	Remedies
General	• Sound cannot be heard from the speakers.	The volume level is set to the minimum level.	Adjust it to the optimum level.
		Connections are incorrect.	Check the cords and connections.
	• This unit does not work at all.	The built-in microcomputer may have functioned incorrectly due to noise, etc.	Press the reset button on the panel holder after detaching the control panel. (The clock setting and preset stations stored in memory are erased.) (See page 2.)
FM/AM	• SSM (Strong-station Sequential Memory) automatic preset does not work.	Signals are too weak.	Store stations manually.
	• Static noise while listening to the radio.	The antenna is not connected firmly.	Connect the antenna firmly.
Disc Playback	• Disc cannot be played back.	Disc is inserted upside down.	Insert the disc correctly.
	• CD-R/CD-RW cannot be played back.	CD-R/CD-RW is not finalized.	• Insert a finalized CD-R/CD-RW.
	• Tracks on the CD-R/CD-RW cannot be skipped.		• Finalize the CD-R/CD-RW with the component which you used for recording.
	• Disc cannot be ejected.	Disc is locked.	Unlock the disc. (See page 16.)
	• Disc sound is sometimes interrupted.	You are driving on rough roads.	Stop playback while driving on rough roads.
		Disc is scratched.	Change the disc.
		Connections are incorrect.	Check the cords and connections.
• "NO DISC" appears on the display.	No disc in the loading slot.	Insert a disc into the loading slot.	
	Disc is inserted incorrectly.	Insert the disc correctly.	



Symptoms	Causes	Remedies
<ul style="list-style-type: none"> Disc cannot be played back. 	No MP3/WMA files are recorded on the disc.	Change the disc.
	MP3/WMA files do not have the extension code—<.mp3> or <.wma> in their file names.	Add the extension code —<.mp3> or <.wma> to their file names.
	MP3/WMA files are not recorded in the format compliant with ISO 9660 Level 1, Level 2, or Joliet.	Change the disc. (Record MP3/WMA files using a compliant application.)
<ul style="list-style-type: none"> Noise is generated. 	The file played back is not an MP3/WMA file (although it has the extension code—<.mp3> or <.wma>).	Skip to another file or change the disc. (Do not add the extension code—<.mp3> or <.wma>) to non-MP3/non-WMA files.)
<ul style="list-style-type: none"> A longer readout time is required (“CHECK” keeps flashing on the display). 	Readout time varies due to the complexity of the folder/file configuration.	Do not use too many hierarchies and folders.
<ul style="list-style-type: none"> Files cannot be played back as you have intended them to play. 	Playback order is determined when the files are recorded.	_____
<ul style="list-style-type: none"> Elapsed playing time is not correct. 	This sometimes occurs during play. This is caused by how the files are recorded on the disc.	_____
<ul style="list-style-type: none">  indicator flashes on the display. 	The current folder does not contain any MP3/WMA file.	Select another folder.
<ul style="list-style-type: none"> “NO FILES” appears on the display. 	The current disc does not contain any MP3/WMA file.	Insert a disc that contains MP3/WMA files.
<ul style="list-style-type: none"> Correct characters are not displayed (e.g. album name). 	This unit can only display alphabets (capital: A–Z), numbers, and a limited number of symbols.	_____

MP3/WMA Playback



	Symptoms	Causes	Remedies
CD Changer	• “NO DISC” appears on the display.	No disc is in the magazine.	Insert discs into the magazine.
		Discs are inserted upside down.	Insert discs correctly.
	• “NO MAG” appears on the display.	No magazine is loaded in the CD changer.	Insert the magazine.
	• “RESET 8” appears on the display.	This unit is not connected to the CD changer correctly.	Connect this unit and the CD changer correctly and press the reset button of the CD changer.
	• “RESET 1” – “RESET 7” appears on the display.	_____	Press the reset button of the CD changer.
	• The CD changer does not work at all.	The built-in microcomputer may function incorrectly due to noise, etc.	Press the reset button on the panel holder after detaching the control panel. (The clock setting and preset stations stored in memory are erased.) (See page 2.)

About mistracking:

Mistracking may result from driving on extremely rough roads. This does not damage the unit and the disc, but will be annoying.

We recommend that you stop disc play while driving on such rough roads.



Handling discs

This unit has been designed to reproduce CDs, CD-Rs (Recordable), CD-RWs (Rewritable), and CD Texts.

• **This unit is also compatible with MP3 and WMA discs.**

How to handle discs

When removing a disc from its case, press down the center holder of the case and lift the disc out, holding it by the edges.

Center holder



• Always hold the disc by the edges. Do not touch its recording surface.

When storing a disc into its case, gently insert the disc around the center holder (with the printed surface facing up).

• Make sure to store discs into the cases after use.

To keep discs clean

A dirty disc may not be played correctly.

If a disc does become dirty, wipe it with a soft cloth in a straight line from center to edge.



To play new discs

New discs may have some rough spots around the inner and outer edges. If such a disc is used, this unit may reject the disc.

To remove these rough spots, rub the edges with a pencil or ball-point pen, etc.



Moisture condensation

Moisture may condense on the lens inside the CD player in the following cases:

- After starting the heater in the car.
 - If it becomes very humid inside the car.
- Should this occur, the CD player may malfunction. In this case, eject the disc and leave the unit turned on for a few hours until the moisture evaporates.

When playing a CD-R or CD-RW

Before playing back CD-Rs or CD-RWs, read their instructions or cautions carefully.

- Use only “finalized” CD-Rs or CD-RWs.
- Some CD-Rs or CD-RWs may not be played back on this unit because of their disc characteristics, and for the following reasons:
 - Discs are dirty or scratched.
 - Moisture condensation on the lens inside the unit.
 - The pickup lens inside the unit is dirty.
- CD-RWs may require a longer readout time since the reflectance of CD-RWs is lower than that of regular CDs.
- CD-Rs or CD-RWs are susceptible to high temperatures or high humidity, so do not leave them inside your car.
- Do not use following CD-Rs or CD-RWs:
 - Discs with stickers, labels, or protective seal stuck to the surface.
 - Discs on which labels can be directly printed by an ink jet printer.

Using these discs under high temperatures or high humidity may cause malfunctions or damage to discs. For example,

- Stickers or labels may shrink and warp a disc.
- Stickers or labels may be peeled off so discs cannot be ejected.
- Print on discs may get sticky.

Read instructions or cautions about labels and printable discs carefully.

CAUTIONS:

- Do not insert 8 cm discs (single CDs) into the loading slot. (Such discs cannot be ejected.)
- Do not insert any disc of unusual shape—like a heart or flower; otherwise, it will cause a malfunction.
- Do not expose discs to direct sunlight or any heat source or place them in a place subject to high temperature and humidity. Do not leave them in a car.
- Do not use any solvent (for example, conventional record cleaner, spray, thinner, benzine, etc.) to clean discs.

Warped disc



Sticker



Sticker residue

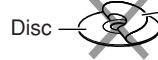

Disc
Stick-on label

SPECIFICATIONS

AUDIO AMPLIFIER SECTION

Maximum Power Output:

Front: 50 W per channel

Rear: 50 W per channel

Continuous Power Output (RMS):

Front: 19 W per channel into 4 Ω , 40 Hz to 20 000 Hz at no more than 0.8% total harmonic distortion.

Rear: 19 W per channel into 4 Ω , 40 Hz to 20 000 Hz at no more than 0.8% total harmonic distortion.

Load Impedance: 4 Ω (4 Ω to 8 Ω allowance)

Tone Control Range

Bass: ± 10 dB at 100 Hz

Treble: ± 10 dB at 10 kHz

Frequency Response: 40 Hz to 20 000 Hz

Signal-to-Noise Ratio: 70 dB

Line-Out Level/Impedance:

2.0 V/20 k Ω load (full scale)

Output Impedance: 1 k Ω

TUNER SECTION

Frequency Range

FM: 87.5 MHz to 108.0 MHz

AM: 531 kHz to 1 602 kHz

[FM Tuner]

Usable Sensitivity: 11.3 dBf (1.0 μ V/75 Ω)

50 dB Quietening Sensitivity:

16.3 dBf (1.8 μ V/75 Ω)

Alternate Channel Selectivity (400 kHz):

65 dB

Frequency Response: 40 Hz to 15 000 Hz

Stereo Separation: 35 dB

Capture Ratio: 1.5 dB

[AM Tuner]

Sensitivity: 20 μ V

Selectivity: 35 dB

CD PLAYER SECTION

Type: Compact disc player

Signal Detection System: Non-contact optical pickup (semiconductor laser)

Number of channels: 2 channels (stereo)

Frequency Response: 5 Hz to 20 000 Hz

Dynamic Range: 96 dB

Signal-to-Noise Ratio: 98 dB

Wow and Flutter: Less than measurable limit

MP3 decoding format:

MPEG 1/2 Audio Layer 3

Max. Bit Rate: 320 Kbps

WMA (Windows Media[®] Audio) decoding format:

Max. Bit Rate: 192 Kbps

GENERAL

Power Requirement

Operating Voltage:

DC 14.4 V (11 V to 16 V allowance)

Allowable Operating Temperature:

0°C to +40°C

Grounding System: Negative ground

Dimensions (W \times H \times D):

Installation Size (approx.):

182 mm \times 52 mm \times 150 mm

Panel Size (approx.):

188 mm \times 58 mm \times 12 mm

Mass (approx.):

1.4 kg (excluding accessories)

Design and specifications are subject to change without notice.

Having TROUBLE with operation?
Please reset your unit
 Refer to page of How to reset your unit

JVC

راديو مع مشغل CD

KD-SC605

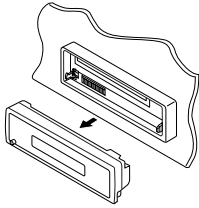
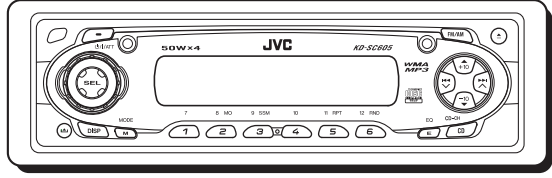
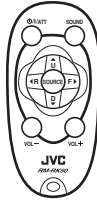

**WMA
MP3**

**COMPACT
disc
DIGITAL AUDIO
TEXT**

هذا الجهاز مزود بوظيفة استعراض الشاشة. لإلغاء وظيفة استعراض الشاشة، انظر صفحة ٨.

لعمليات التركيب والتوصيلات، يرجى مراجعة كتيب التعليمات المنفصل.

دليل التعليمات



EN, CT, TH, AR
© 2003 VICTOR COMPANY OF JAPAN, LIMITED



1003KKSFLEJEN

JVC KD-SC605

Installation/Connection Manual

安裝/連接手冊
 การติดตั้ง/คู่มือการติดตั้ง
 كتيب تعليمات التركيب/التوصيل
 GET0188-003A
 [U]

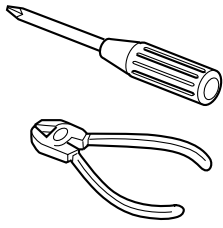

1003KKSFLJEJIN
 EN, CT, TH, AR

ENGLISH

- This unit is designed to operate only on 12 V DC, NEGATIVE ground electrical systems.

INSTALLATION (IN-DASH MOUNTING)

- The following illustration shows a typical installation. However, you should make adjustments corresponding to your specific car. If you have any questions or require information regarding installation kits, consult your JVC car audio dealer or a company supplying kits.

- Before mounting:** Press (control panel release button) to detach the control panel if already attached.
 - When shipped from the factory, the control panel is packed in the hard case.
- Remove the trim plate.
- Remove the sleeve after disengaging the sleeve locks.
 - Stand the unit.
 - Note:** When you stand the unit, be careful not to damage the fuse on the rear.
 - Insert the 2 handles between the unit and the sleeve, as illustrated, to disengage the sleeve locks.
 - Remove the sleeve.
 - Note:** Be sure to keep the handles for future use after installing the unit.
- Install the sleeve into the dashboard.
 - After the sleeve is correctly installed into the dashboard, bend the appropriate tabs to hold the sleeve firmly in place, as illustrated.
- Fix the mounting bolt to the rear of the unit's body and place the rubber cushion over the end of the bolt.
- Do the required electrical connections.
- Slide the unit into the sleeve until it is locked.
- Attach the trim plate.
 - Note:** Ensure the recessed part is at the bottom. If not, the control panel will not open completely.
- Attach the control panel.

中文

- 本機僅可使用直流 12V、負極接地的電源系統。

安裝 (裝設、固定在儀表板內)

- 下面的圖解表示了典型的安裝程序。然而，您應當做些適當的調整，以便適應您自己的汽車。如果您有問題，或需要有關配套元件的資料，請向 JVC 汽車音響分銷商或配套元件供應商查詢。

- 裝設之前：**如果控制面板已經裝上，按下 (控制面板解脫按鈕)，拆脫控制面板。
 - 當控制面板從工廠裝運時，它是包裝在硬盒中的。
- 取下裝飾框。
- 解開扣板，取下本機的外套機殼。
 - 將本機豎起。
 - 注意：**您豎起本機時，小心不要損壞底部的保險絲。
 - 按圖所示，在本機和外套機殼之間插入兩片板條型的把手，解開外套機殼扣板。
 - 取下外套機殼。
 - 注意：**安裝本機後，務必保存好兩片把手，以備將來使用。
- 將外套機殼裝入儀表板內。
 - 在外套機殼準確地裝入儀表板之後，按圖所示，彎曲機殼的突舌，把外套機殼牢固在儀表板內。
- 將緊固螺栓旋緊在本機機體上，並將橡膠防震墊套在緊固螺栓的尾部。
- 進行所需的電路連接。
- 將本機滑入外套機殼，直到扣板鎖住為止。
- 裝上裝飾框。
 - 注意：**確保凹入部分已在底部。如果不在底部，控制面板將不被完整打開。
- 裝上控制面板。

ไทย

- ชุดประกอบนี้ได้รับการออกแบบมาเพื่อใช้ร่วมกับระบบ กระแสไฟฟ้าสายดินขั้วลบกระแสตรง 12 โวลท์ หากรถยนต์ของคุณไม่ได้ใช้ระบบนี้ ต้องใช้เครื่องแปลงกระแสไฟฟ้าช่วย

การติดตั้ง (การประกอบแผงหน้าปัด)

- ภาพตัวอย่างต่อไปนี้แสดงถึงการติดตั้งแบบทั่วไป อย่างไรก็ตาม คุณควรปรับแต่งให้เหมาะสมกับรถของคุณเอง หากคุณมีปัญหาคือการถอดข้อมูลเกี่ยวกับชุดติดตั้ง กรุณาปรึกษากับผู้เชี่ยวชาญเรื่องเสียงรถยนต์ JVC ของท่านหรือบริษัทที่จำหน่ายชุดติดตั้งนี้ที่จำหน่ายชุดติดตั้งนี้
- ก่อนประกอบ** กดปุ่ม (ปลดแผงควบคุม) เพื่อออกจากแผงควบคุม
 - เมื่อผลิตภัณฑ์ถูกส่งออกมาจากโรงงาน แผงหน้าปัดจะบรรจุไว้ในกล่องแข็ง
- ถอดแผ่นโลหะขอบแดงออก
 - ถอดปลอกหุ้มออกหลังจากปลดที่ล็อกปลอกหุ้มออกแล้ว
 - จับชุดประกอบตั้งขึ้น
 - หมายเหตุ :** เมื่อคุณตั้งชุดประกอบขึ้น ระหว่างอย่าทำให้ตัวสวิตช์บริเวณส่วนท้ายเสียหาย
 - ใส่คั่นบังคับ 2 อันระหว่างชุดประกอบกับปลอกหุ้ม (ดูภาพ) เพื่อปลดที่ล็อกปลอกหุ้มออกจากกัน
 - ปลดปลอกหุ้มออก
 - หมายเหตุ :** ระวังอย่าให้คั่นบังคับสามารถใช้งานได้อีกต่อไปหลังจากติดตั้งชุดประกอบแล้ว
 - ติดตั้งปลอกหุ้มลงในแผงหน้าปัด
 - หลังจากติดตั้งปลอกหุ้มลงในแผงหน้าปัดอย่างถูกต้องแล้ว ดัดร่องให้โค้งพอดีที่ปลอกหุ้มจะถูกยึดไว้อย่างแน่นหนา (ดูภาพ)
 - ติดตั้งปลอกหุ้มบริเวณด้านหลังโครงของชุดประกอบและวางขั้วกันกระแทกไว้บนส่วนปลายของสลัก
 - ดัดสายไฟตามที่กำหนดไว้ทั้งหมด
 - เลื่อนชุดประกอบลงในปลอกหุ้มจนเข้ากันได้พอดี
 - ต่อแผ่นโลหะขอบแดง
 - หมายเหตุ:** เวลาใส่ต้องแน่ใจว่า ตัวล็อกอยู่ทางด้านล่าง มิฉะนั้นแล้ว จะเปิดแผงควบคุมออกไม่ได้ทั้งหมด
 - ต่อเข้ากับแผงควบคุม

عربي

- لقد صمم هذا الجهاز لي عمل فقط بواسطة تيار كهربائي مباشر DC، ١٢ فولت، أنظمة كهربائية تاريسخ سالب.

تركيب الجهاز (داخل - تابلو السيارة)

- يبيّن الرسم التوضيحي التالي طريقة التركيب المثالية. مع ذلك، يجب عليك عمل تعديلات تطابق نوع السيارة التي تمتلكها. إذا كان هناك استفسارات أو حاجة لمعلومات بخصوص أدوات التركيب، يرجى استشارة موزع الأجهزة الصوتية للسيارات ماركة JVC أو الشركة الموزعة لهذه الأدوات.
- قبل بدء التركيب:** اضغط الرز (زر تحرير لوحة التحكم) من أجل فصل لوحة التحكم عند الشحن من المصنع، تم وضع لوحة التحكم داخل الصندوق.
- انزع لوحة الزينة.
- انزع الهيكل الواقي بعد فصل مثبتات الهيكل الواقي.
 - أوقف الجهاز بشكل عمودي.
 - ملاحظة:** عند توقيف الجهاز، تأكد من عدم تضرر أو اتلاف الفيوز الموجود في الجهة الخلفية من الجهاز.
 - ادخل المساكين بين الجهاز والهيكل الواقي، كما هو مبين في الشكل، لفصل مثبتات الهيكل الواقي.
 - انزع الهيكل الواقي.
- ملاحظة:** يرجى المحافظة على المساكات من أجل الاستعمال لاحقاً بعد تركيب الجهاز.
 - ركب الهيكل الواقي داخل تابلو السيارة.
 - بعد تركيب الهيكل الواقي كلياً داخل تابلو السيارة بشكل صحيح، أثنى الألسنة بشكل مناسب لتثبيت الهيكل الواقي بشكل محكم في المكان الصحيح، كما هو مبين في الشكل.
 - ثبت مسام التركيب بالجهة الخلفية من هيكل الجهاز وبعد ذلك ضع الحشوة المطاطية فوق نهاية المسام.
 - عمل التوصيلات الكهربائية المطلوبة كما هو مشروح خلف هذه التعليمات.
 - ادخل الجهاز داخل الهيكل الواقي حتى يثبت بشكل صحيح.
 - ركب لوحة الزينة.
 - ملاحظة:** تأكد من أن القسم المجوف في الأسفل بخلاف ذلك، سوف لا تفتح لوحة التحكم بصورة كاملة.
 - ركب لوحة التحكم.

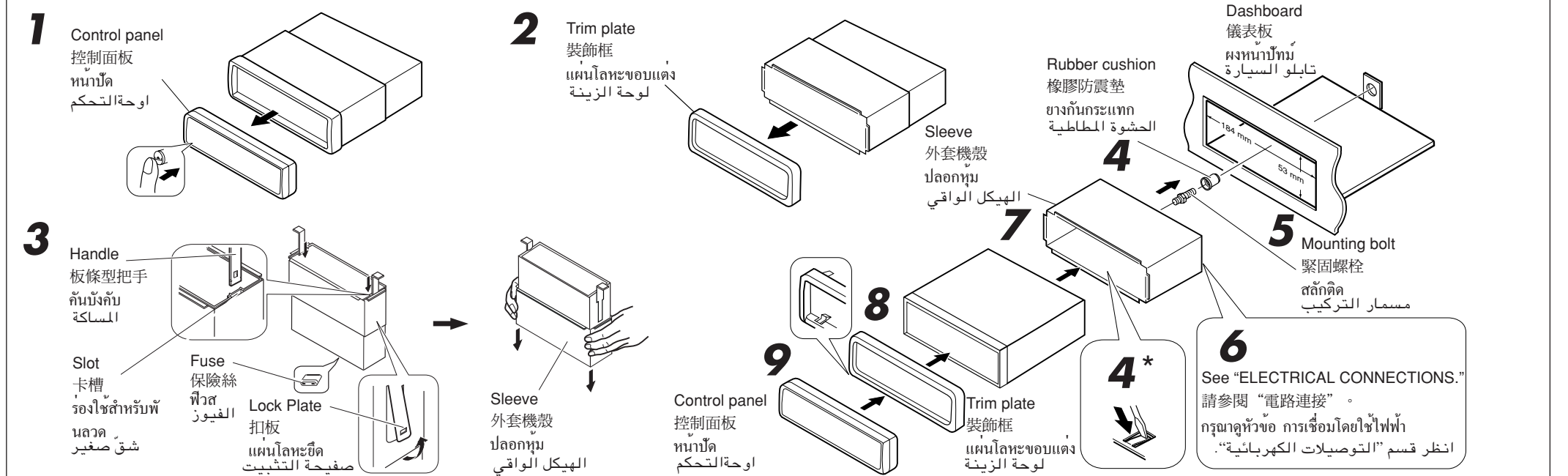

ELECTRICAL CONNECTIONS

To prevent short circuits, we recommend that you disconnect the battery's negative terminal and make all electrical connections before installing the unit. If you are not sure how to install this unit correctly, have it installed by a qualified technician.

- Note:**
 This unit is designed to operate only on 12 V DC, NEGATIVE ground electrical systems. If your vehicle does not have this system, a voltage inverter is required, which can be purchased at JVC car audio dealers.
- Replace the fuse with one of the specified rating. If the fuse blows frequently, consult your JVC car audio dealer.
 - If noise is a problem... This unit incorporates a noise filter in the power circuit. However, with some vehicles, clicking or other unwanted noise may occur. If this happens, connect the unit's rear ground terminal (see connection diagram) to the car's chassis using shorter and thicker cords, such as copper braiding or gauge wire. If noise still persists, consult your JVC car audio dealer.
 - It is recommended to connect to the speakers with maximum power of more than 50 W (both at the rear and at the front, with an impedance of 4 Ω to 8 Ω.). If the maximum power is less than 50W, change "AMP GAIN" setting to prevent the speakers from being damaged (see page 28 of the INSTRUCTIONS).
 - Be sure to ground this unit to the car's chassis.**
 - The heat sink becomes very hot after use. Be careful not to touch it when removing this unit.



電路連接

為防止短路，建議在安裝本機之前，斷開電池的負極，並把所有電路都連接好。如果您不能確定如何正確地安裝本機，應請合格的技術人員來安裝。

- 注意：**
 本機僅可使用直流 12V、負極接地的電源系統。如果您的車輛沒有這一電源系統，則需要一個電壓變換器，可以在 JVC 汽車音響分銷商處買到。
- 把保險絲更換為額定負荷值的保險絲。如果保險絲經常燒壞，請向 JVC 汽車音響分銷商詢問。
 - 若出現噪音問題... 本機在電源回路帶有一個噪音濾波器。但是，在某些車輛上，會出現咯咯聲或其它噪音。如果發生這類情況，將本機後面的接地端子用短而粗的導線，如編織銅線或標準電纜，連接到汽車底盤上（參閱電路接線圖）。如果噪音仍然持續存在，請向 JVC 汽車音響分銷商詢問。
 - 後置和前置揚聲器的最大輸入功率應大於 50 W，其阻抗為 4 Ω - 8 Ω。如果最大功率小於 50 W，請調校 "AMP GAIN" 設定值，以防止揚聲器損壞（參閱使用說明書第 28 頁）。
 - 務必將本機的地線接到汽車底盤上。
 - 本機使用後，散熱片會很熱。因此，在移出本機時，小心不要觸摸散熱片。

การเชื่อมโดยใช้ไฟฟ้า

เพื่อป้องกันไฟฟ้าลัดวงจรเราขอแนะนำให้คุณถอดขั้วลบแบตเตอรี่ออกก่อนและทำการเชื่อมต่อโดยใช้ไฟทุทุกจุดก่อนที่จะติดตั้งชุดประกอบของคุณไม่ได้ใช้ระบบนี้ ต้องใช้เครื่องแปลงกระแสไฟฟ้าช่วย

- หมายเหตุ :**
 ชุดประกอบนี้ได้รับการออกแบบมาเพื่อใช้ร่วมกับระบบกระแสไฟฟ้าสายดินขั้วลบกระแสตรง 12 โวลท์ หากรถยนต์ของคุณไม่ได้ใช้ระบบนี้ ต้องใช้เครื่องแปลงกระแสไฟฟ้าช่วยซึ่งสามารถหาซื้อได้จากร้านขายเครื่องเสียงรถยนต์ JVC
- ใช้ฟิวส์ที่เฉพาะแทนฟิวส์ หากฟิวส์ขาดบ่อย ให้ปรึกษาร้านขายเครื่องเสียงรถยนต์ JVC
 - หากเสียงมีปัญหา... ชุดประกอบชุดนี้มีเครื่องกรองเสียงในวงจรกำลัง อย่างไรก็ตาม บางครั้งก็อาจเกิดเสียงที่ไม่พึงปรารถนาขึ้นได้ หากปัญหานี้เกิดขึ้น ให้ถอดขั้วสายดินด้านหลังของชุดประกอบ (ดูแผนภูมิการต่อเชื่อมด้านหน้า) เชื่อมกับแชสซีส์ของรถยนต์โดยใช้สายเคเบิลที่สั้นและหนักกว่า เช่น สายไฟเครื่องวัดหรือสายประสานทองแดง เป็นต้น หากยังมีเสียงอยู่ก็ ให้ปรึกษาร้านขายเครื่องเสียงรถยนต์ JVC
 - ขอแนะนำให้ต่อสายไฟที่มีกำลังขั้วสูงสุดเกินกว่า 50 W (ทั้งกำลังที่หน้าและด้านหลัง โดยมีมิตที่เด่นชัดใน 4 Ω ถึง 8 Ω) ถ้ากำลังขั้วสูงสุดต่ำกว่า 50 W ให้เปลี่ยน "AMP GAIN" ที่ตั้งไว้ใหม่เพื่อป้องกันไม่ให้ไฟไหม้เสียหาย (ดูขอแนะนำการใช้งานในหน้า 28)
 - ตรวจสอบให้แน่ใจว่าได้ต่อชุดประกอบชุดนี้ลงในแชสซีส์รถยนต์แล้ว
 - แผ่นระบายความร้อนจะร้อนมากหลังจากใช้ ระวังอย่าไปสัมผัสเมื่อถอดชุดประกอบนี้

التوصيلات الكهربائية

لمنع حدوث تقصير في الدوائر الكهربائية، نوصي بفصل طرف البطارية السالبة ثم عمل التوصيلات الكهربائية قبل تركيب الجهاز. في حالة عدم معرفتك كيفية تركيب الجهاز بشكل صحيح، يرجى ترك عملية تركيب الجهاز لشخص مختص ومؤهّل لتركيب مثل هذه الأجهزة.

- ملاحظة:**
 لقد صمم هذا الجهاز لي عمل فقط بواسطة تيار كهربائي مباشر DC، ١٢ فولت، أنظمة كهربائية تاريسخ سالب. في حالة عدم وجود مثل هذا النظام في سيارتك، يجب استخدام محول فولتاج، ويمكن شراء هذا المحول من وكلاء الأجهزة الصوتية للسيارات ماركة JVC.
- استبدل الفيوز بأخر يحمل نفس القياسات الموصوفة. إذا تكرر احتراق الفيوز، يرجى استشارة وكلاء الأجهزة الصوتية للسيارات ماركة JVC.
 - إذا كان الضجيج هو المشكلة... يستخدم هذا الجهاز فلتر ضجيج داخل دائرة الطاقة الكهربائية. مع ذلك، في بعض السيارات، يمكن أن يحدث نوع من اللقطعة أو الضجيج غير المرغوب. في حالة حدوث مثل ذلك، أوصل طرف التاريسخ الموجود في خلفية الجهاز (انظر رسم التوصيل في الأسفل) مع هيكل السيارة بواسطة استخدام اسلاك اقصر واسمك، مثل سلك النحاس المجود أو سلك مقاييس. في حالة عدم توقف اللقطعة أو الضجيج، يرجى استشارة وكلاء الأجهزة الصوتية للسيارات ماركة JVC.
 - نوصي بالتوصيل مع سماعات ذات حد أقصى للطاقة أكثر من ٥٠ واط (كلا من السماعات الخلفية والأمامية، بممانعة من ٤ اوم الى ٨ اوم). إذا كان الحد الأقصى لطاقة السماعات اقل من ٥٠ واط، غير ضبط "AMP GAIN" لمنع حصول ضرر للسماعات (انظر صفحة ٢٨ من كتيب تعليمات التشغيل).
 - تأكد من تاريسخ الجهاز مع هيكل السيارة.
 - تصحيح صفحه خفض الحرارة ساخنة جدا بعد الاستخدام. تأكد من عدم ملاستها عند نزع الجهاز.

- When using the optional stay
- 若選用支撐架
- เมื่อใช้ตัวยึดแบบเลือกได้ (สามารถเลือกเปิดค้างไว้ได้) عند استخدام مسند اضافي للتثبيت

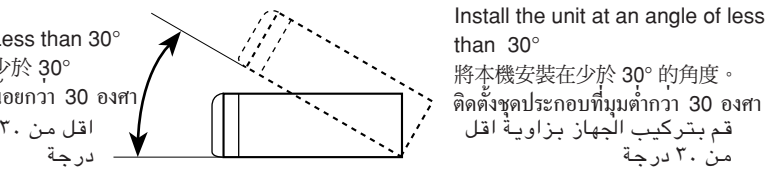
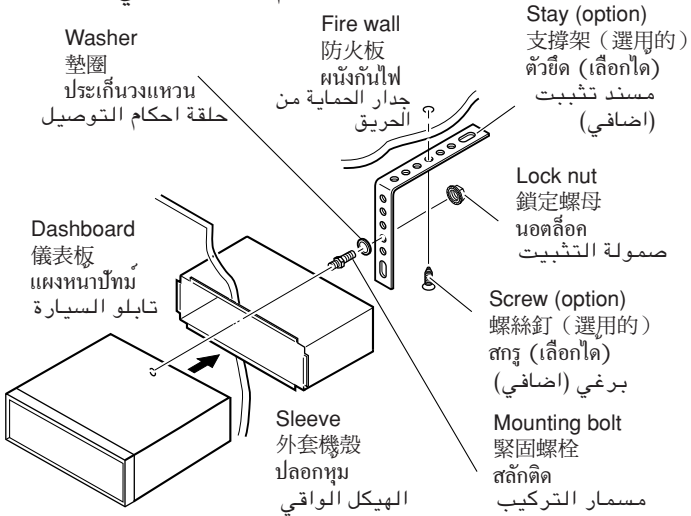

- When installing the unit without using the sleeve
- 若不使用外套機殼安裝本機
- เมื่อติดตั้งชุดประกอบโดยไม่มีปลอกหุ้ม
- عندما تركيب الجهاز بدون استخدام الهيكل الواقي

In a Toyota for example, first remove the car radio and install the unit in its place. In a Toyota (TOYOTA) 汽車為例：首先取出汽車收音機，然後將本機裝入其空出的位置。ตัวอย่างเช่น ในรถยนต์โตโยตา ให้ถอดวิทยุติดรถยนต์ออกก่อนและติดตั้งชุดประกอบนี้เข้าไปแทนที่บนที่วางวิทยุ ในรถยนต์ Toyota, ถอดวิทยุ Toyota ออกจากที่วางวิทยุก่อนแล้วนำชุดประกอบนี้ไปติดตั้งบนที่วางวิทยุ.

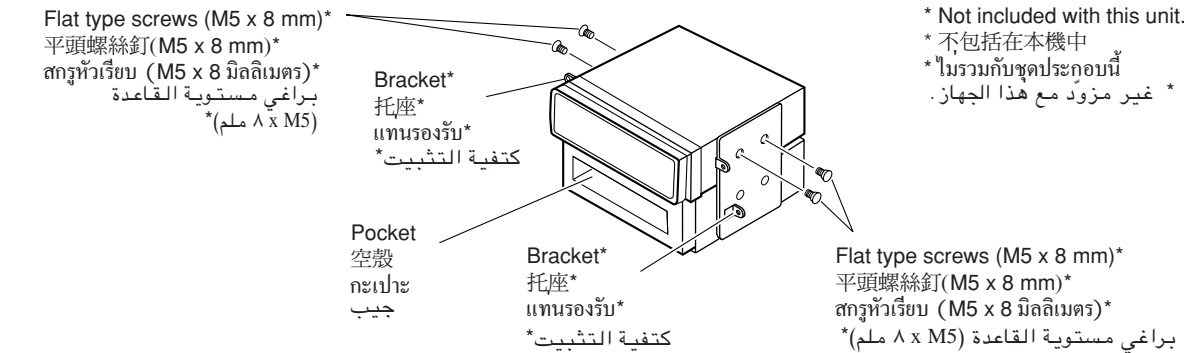

Note: When installing the unit on the mounting brackets, make sure to use the 8 mm-long screws. If longer screws are used, they could damage the unit. 注意：把本機安裝在托座上時，務必使用 8mm 長的螺絲釘。如使用過長的螺絲釘，會損壞本機。

หมายเหตุ : เมื่อติดตั้งชุดประกอบลงในแท่นรองรับไว้ ให้ใช้สกรูยาวขนาด 8 มิลลิเมตร ถ้าใช้สกรูยาวกว่านี้อาจทำให้ชุดประกอบเสียหายได้ 注意: عند تركيب الجهاز على كتفية التثبيت، تأكد من استخدام براغي طول 8 ملم. في حالة استخدام براغي اطول من 8 ملم، فإن ذلك يمكن ان يسبب تلف او ضرر للجهاز.

Removing the unit

- Before removing the unit, release the rear section.
- 1 Remove the control panel.
- 2 Remove the trim plate.
- 3 Insert the 2 handles into the slots, as shown. Then, while gently pulling the handles away from each other, slide out the unit. (Be sure to keep the handles after installing it.)

拆卸本機

- 在拆卸本機前，應將本機後部的固定和連接部分鬆開。
- 1 拆下控制面板。
- 2 取下裝飾框。
- 3 按圖所示，將兩片板條型把手插入卡槽，然後輕輕地從兩側向外拉兩片把手，本機隨之拉出。（安裝本機後，務必保存好兩片把手。）

การถอดชุดประกอบ

- ก่อนจะถอดชุดประกอบ ให้ปลดหน้าตัดส่วนท้ายก่อน
- 1 ถอดแผงควบคุม
- 2 ถอดแผ่นโลหะขอบแต่ง
- 3 ใส่คันทิ้งกับ 2 อันลงในร่องสำหรับใส่คันทิ้ง แล้วดึงภาพ จากนั้นให้เลื่อนชุดประกอบออก ในขณะที่กดคันทิ้งทั้งสองอันออกจากกัน (ดูให้ดูว่าคันทิ้งทั้งสองอันอยู่ในตำแหน่งที่เหมาะสมหลังจากติดตั้งแล้ว)

نزع الجهاز من تابلو السيارة

- قبل نزع الجهاز، حرر الجزء الخلفي.
- 1 انزع لوحة التحكم.
- 2 انزع لوحة الزينة.
- 3 ادخل المساكين داخل الشقوق، كما هو مبين في الشكل. بعد ذلك، اثناء سحب المساكين بلطف بعيدا الواحدة عن الاخرى، اسحب الجهاز الى الخارج. (تأكد من احتفاظك بالمساكين بعد تركيب الجهاز.)

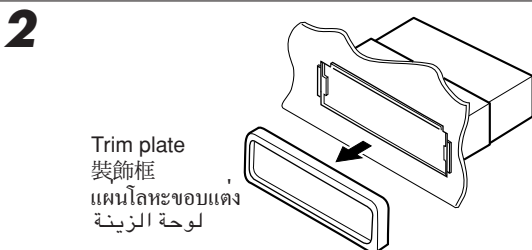
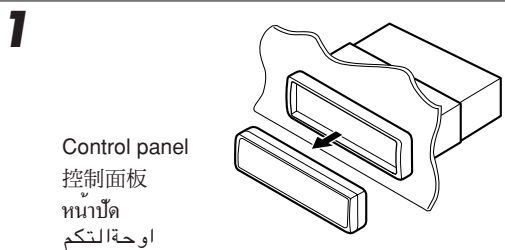

Parts list for installation and connection

The following parts are provided with this unit. After checking them, please set them correctly.

用於安裝和連接的零件裏

下列零件是隨本機提供的。請點以後，正確的將其裝配。

รายการส่วนประกอบสำหรับติดตั้งและเชื่อมต่อกัน

ส่วนประกอบต่อไปนี้ใหม่กับชุดประกอบนี้ หลังจากตรวจสอบแล้ว โปรดตั้งเครื่องให้ถูกต้อง

قائمة اجزاء التركيب والتوصيل

الاجزاء التالية مزودة مع الجهاز. بعد فحص هذه الاجزاء، يرجى تركيبهم بشكل صحيح.

Hard case/Control panel
硬盒 / 控制面板
กล่องควบคุม / หน้าปัด
صندوق صلب / اوحة التحكم

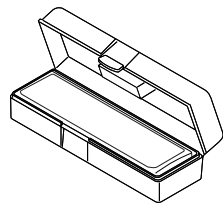

Sleeve
外套機殼
ปลอกหุ้ม
الهيكل الواقي

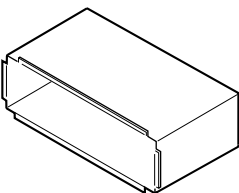

Trim plate
裝飾框
แผ่นโลหะขอบแต่ง
لوحة الزينة

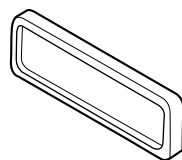

Remote controller
遙控器
รีโมตคอนโทรล
وحدة التحكم عن بعد

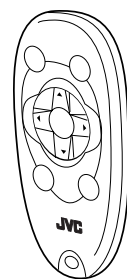

Power cord
電路連接用的配線束
สายเคเบิลกำลัง
سلك الطاقة الكهربائية

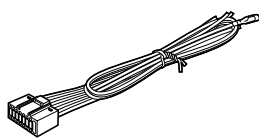

Handles
板條型把手
คันทิ้ง
المساکين

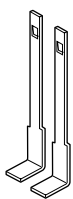

Mounting bolt (M5 x 20 mm)
緊固螺絲 (M5 x 20 mm)
สลักก๊อต (M5 x 20 มิลลิเมตร)
مسامير التركيب (M5 x 20 ملم)



Rubber cushion
橡膠防震墊
ยางกันกระแทก
الحشوة المطاطية



Washer (ø5)
墊圈 (ø5)
ประเก็นวงแหวน (ø5)
حلقة احكام التوصيل (قطر 5)



Lock nut (M5)
鎖定螺母 (M5)
นอตล็อก (M5)
صمولة التثبيت (M5)



Battery
電池
แบตเตอรี่
البطاريات



See pages 30 and 31 of the Instructions for the usage of the following parts.

請參閱第 30 和 31 頁有關以下配件的使用指示。

ดูหน้า 30 และ 31 ของคู่มือใช้งาน สำหรับการใช้นับส่วนดังต่อไปนี้

انظر الصفحات 30 و 31 من كتيب تعليمات التشغيل حول كيفية استعمال الاجزاء التالية.

Additional standard plates (3) and transparent plate (1)
額外的標準圖板 (3) 和透明圖板 (1)
เพลามาตรฐานเพิ่มเติม (3) และเพลทใส (1)
صفائح قياسية اضافية (3) مع صفيحة شفافة (1)

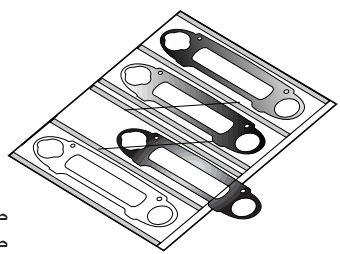

Cutout plates (printed on the sheet) (4)
剪切圖板 (印在紙張上) (4)
เพลตตัดเอาท (พิมพ์บนแผ่นกระดาษสติ๊กเกอร์) (4)
صفائح معدة مسبقا (مطبوعة على الورقة) (4)



Spare screws for the plate cover attachment—M2 x 5 mm (2)
用以連接圖板蓋子的備用螺絲—M2 x 5 mm (2)
สกรูยึดสำรองสำหรับติดตั้งแผงปิดเพลท—M2 x 5 mm (2)
براغي احتياطية للملحقة غطاء الصفيحة—M2 x 5 mm (2)



Hex screwdriver (1)
六角螺絲起子 (1)
ไขควงหกเหลี่ยม (1)
مفك براغي سداسي (1)



TROUBLESHOOTING

故障排除

การตรวจสอบปัญหาหัดข้อง

البحث عن الاعطال والاصلاح

- The fuse blows.
* Are the red and black leads connected correctly?
- Power cannot be turned on.
* Is the yellow lead connected?
- No sound from the speakers.
* Is the speaker output lead short-circuited?
- Sound is distorted.
* Is the speaker output lead grounded?
* Are the “-” terminals of L and R speakers grounded in common?
- Unit becomes hot.
* Is the speaker output lead grounded?
* Are the “-” terminals of L and R speakers grounded in common?

- 保險絲燒斷。
* 檢查紅色導線接頭和黑色導線接頭是否連接正確？
- 電源不能接通。
* 檢查黃色導線接頭是否接上？
- 揚聲器沒有聲音。
* 檢查揚聲器輸出導線接頭是否短路？
- 聲音失真。
* 檢查揚聲器輸出端子是否接地？
* 檢查揚聲器的左 (L)、右 (R) 端子的負極 (-) 是否共同接地？
- 本機發熱。
* 檢查揚聲器輸出端子是否接地？
* 檢查揚聲器的左 (L)、右 (R) 端子的負極 (-) 是否共同接地？

- ฟิวส์ขาด
* มีการเชื่อมสายตะกั่วสีแดงและสีแสดอย่างถูกต้องหรือไม่
- ไม่สามารถเปิดเครื่องได้
* มีการเชื่อมสายตะกั่วสีเหลืองหรือไม่
- ไม่มีเสียงออกจากลำโพง
* สายตะกั่วส่วนที่ออกทางลำโพงเกิดไฟฟ้าลัดวงจรหรือไม่
- เสียงเพี้ยน
* สายตะกั่วส่วนที่ออกทางลำโพงต่อลงดินหรือไม่
* สายขั้วลบ ของลำโพงด้านซ้ายและขวาต่อลงดินตามปกติหรือไม่
- ชุดประกอบร้อนขึ้น
* สายตะกั่วที่ออกทางลำโพงต่อลงดินหรือไม่
* สายขั้วลบ ของลำโพงด้านซ้ายและขวาต่อลงดินตามปกติหรือไม่

- يحدث قفز الفيوز.
* هل السلك الاحمر والاسود موصول بشكل صحيح؟
- لا يمكن توصيل الطاقة الكهربائية.
* هل السلك الاصفر موصول؟
- لا يصدر صوت من السماعات.
* هل هنالك تقصير في دائرة سلك خرج السماعة؟
- الصوت مشوه.
* هل سلك خرج السماعة موصول بالارض؟
* هل الاطراف السالبة “-” للسماعة اليسرى L واليمنى R موصولة بالارض مع بعض؟
- يسخن الجهاز.
* هل سلك خرج السماعة موصول بالارض؟
* هل الاطراف السالبة “-” للسماعة اليسرى L واليمنى R موصولة بالارض مع بعض؟

Typical Connections / 典型的接線方法 / การเชื่อมต่อแบบปกติ / التوصيلات النموذجية

Before connecting: Check the wiring in the vehicle carefully. Incorrect connection may cause serious damage to this unit.

The leads of the power cord and those of the connector from the car body may be different in color.

- 1 Connect the colored leads of the power cord to the car battery, speakers and automatic power antenna (if any) in the following sequence.
1 Black: ground
2 Yellow: to car battery (constant 12 V)
3 Red: to an accessory terminal
4 Blue with white stripe: to remote lead of other equipment (200 mA max.)
5 Blue: to automatic antenna if any (250 mA max.)
6 Orange with white stripe: to car light control switch
7 Others: to speakers

接線前: 仔細檢查汽車內的線路。不正確的接線會導致本機嚴重損壞。

電力線的引線和車身的連接器引線在顏色上可能有所不同。

- 1 按下述順序將配線束各個不同色標的導線接頭分別接至電池、揚聲器和自動電源升降天線 (如有裝設):
1 黑色: 接地
2 黃色: 接至車裝電池 (恆定 12V)
3 紅色: 接至保險絲單元內的附屬端子
4 藍色帶有白色條紋: 接至其他音響設備 (最大 200 mA)
5 藍色: 接至自動升降天線 (最大 250 mA)
6 橙色帶有白色條紋: 接至汽車燈光控制轉換器
7 其他: 接至揚聲器

ก่อนทำการเชื่อมต่อ: ตรวจสอบการเดินสายไฟในรถอย่างละเอียดก่อนทำการเชื่อมต่อ. การเชื่อมต่อที่ไม่ถูกต้องอาจทำให้เกิดความเสียหายร้ายแรงแก่ชุดอุปกรณ์นี้ได้.

- 1 ต่อสายต่อสีของสายไฟเข้ากับแบตเตอรี่รถยนต์ ลำโพง และเสาอากาศพาวเวอร์อัตโนมัติ (ถ้ามี) ตามลำดับต่อไปนี้
1 สีดำ: สายดิน
2 สีเหลือง: ต่อกับแบตเตอรี่รถยนต์ (12 โวลต์คงที่)
3 สีแดง: ต่อกับขั้วส่วนประกอบ
4 สายสีฟ้าที่มีแถบขาว: ต่อกับขั้วอุปกรณ์อื่น (ขนาดสูงสุด 200 mA)
5 สีฟ้า: ต่อกับขั้วเสาอากาศอัตโนมัติ (ขนาดสูงสุด 250 mA)
6 สีส้มแถบขาว: ต่อกับสวิตช์ควบคุมไฟของรถยนต์
7 สีอื่น ๆ: ต่อกับลำโพง

قبل البدء بالتوصيل: تأكد من شبكة الاسلاك في السيارة بدقة حتى لا يحدث خطأ في عملية توصيل الجهاز. يمكن ان يسبب التوصيل الخاطئ الى حصول عطل حقيقي للجهاز.

- 1 اوصل الاسلاك الملونة لسلك تزويد الطاقة الكهربائية مع بطارية السيارة، السماعات والهوائي الأوتوماتيكي (إن وجد) حسب التسلسل التالي:
1 السلك الأسود: مع الأرض
2 السلك الأصفر: مع بطارية السيارة (ثابت ١٢ فولت)
3 السلك الأحمر: مع الطرف الإضافي
4 السلك الأزرق المخطط بالأبيض: مع الأجهزة الأخرى. (الحد الأقصى ٢٠٠ ميلي أمبير)
5 السلك الأزرق المخطط بالأبيض: مع الهوائي الأوتوماتيكي (الحد الأقصى ٢٥٠ ميلي أمبير)
6 الشريط البرتقالي مع الأبيض: الى مفتاح التحكم بضوء السيارة
7 الاسلاك الأخرى: مع السماعات

- Before connecting the CD changer, make sure that the unit is turned off.
• 連接 CD 轉換器之前，應先將本機關閉。
• ก่อนจะเชื่อมต่อเครื่องเล่นซีดี กรุณาตรวจสอบให้แน่ใจว่าเครื่องเล่นซีดีนั้นปิดอยู่.
• قبل توصيل مبدل الاسطوانة المدمجة، تأكد من إيقاف تشغيل الجهاز.



JVC CD changer jack JVC CD 轉換器插座... We recommend you to connect the JVC MP3-compatible CD changer. You can also connect other CH-X series CD changers (except CH-X99 and CH-X100).

我們建議您連接 JVC MP3 兼容的 CD 換碟器。您也可以連接其它 CH-X 系列的 CD 換碟器 (CH-X99 和 CH-X100 除外)。

ขอแนะนำให้นำหัวต่อซีดีเจมเมอร์ที่สามารถทำงานร่วมกับ JVC MP3 กับเครื่องเล่นของคุณ...

ننصح بتوصيل مبدل اسطوانات مدمجة CD - متوافق مع اسطوانة MP3 من صناعة JVC مع هذا الجهاز.

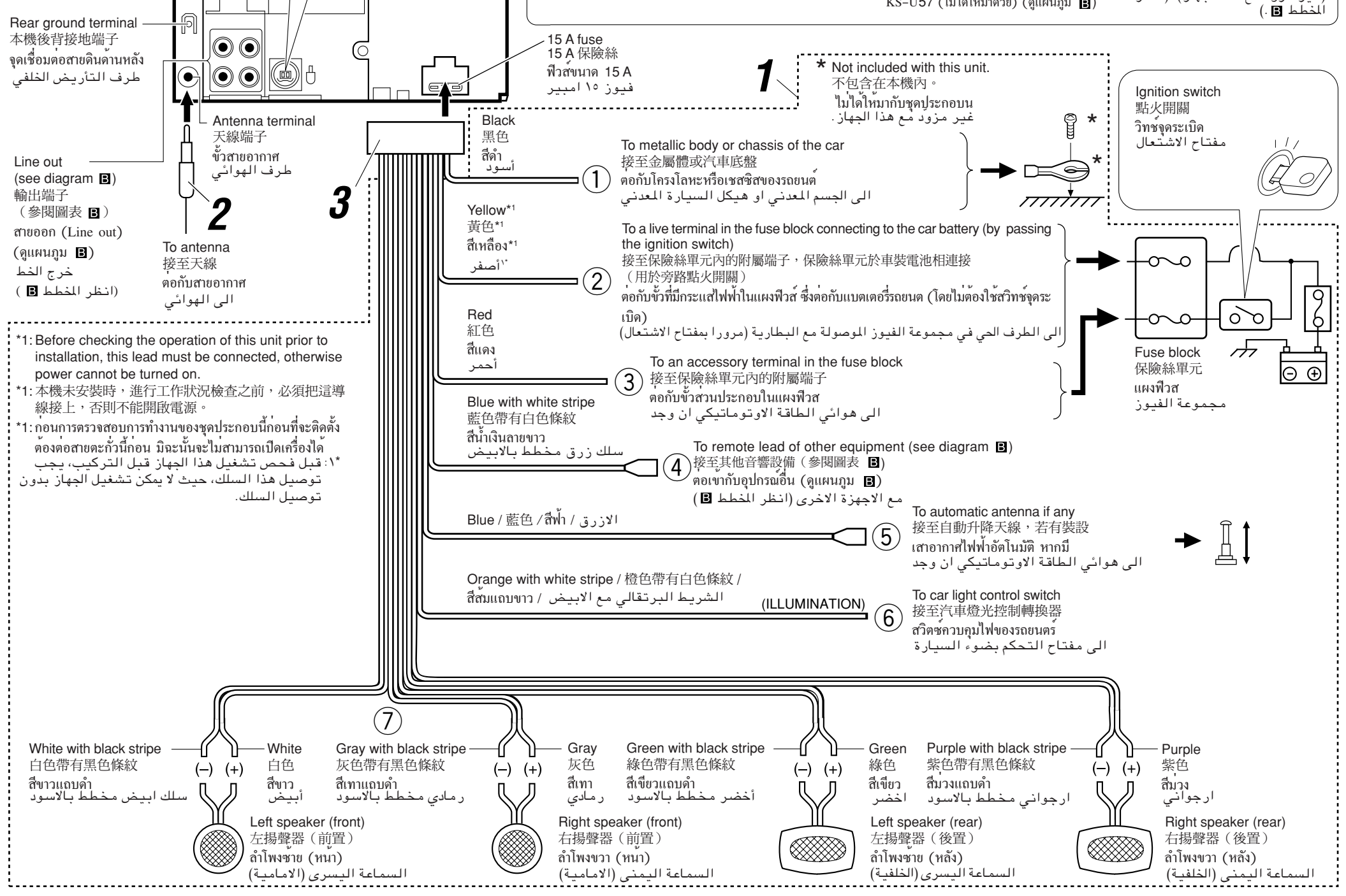

- *1: Before checking the operation of this unit prior to installation, this lead must be connected, otherwise power cannot be turned on.
*1: 本機未安裝時，進行工作狀況檢查之前，必須把這導線接上，否則不能開啟電源。
*1: ก่อนการตรวจสอบการทำงานของชุดประกอบนี้ก่อนที่จะติดตั้ง ต้องต่อสายตะกั่วนี้ก่อน มิฉะนั้นจะไม่สามารถเปิดเครื่องได้
*1: قبل فحص تشغيل هذا الجهاز قبل التركيب، يجب توصيل هذا السلك، حيث لا يمكن تشغيل الجهاز بدون توصيل السلك.

Connecting the leads / 導線接頭的連接 / ต่อสายตะกั่ว / توصيل الاسلاك

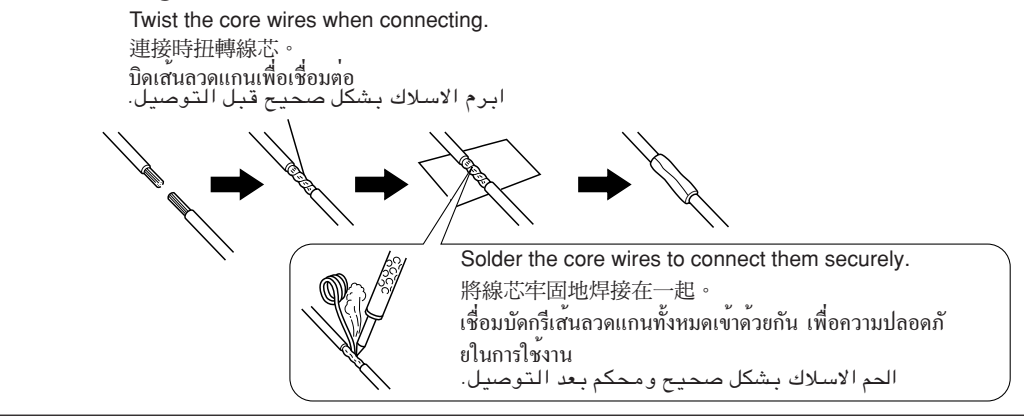

CAUTION / 注意 / ข้อควรระวัง / تنبيه

- To prevent short-circuit, cover the terminals of the UNUSED leads with insulating tape.
• 為防止電源短路，請用絕緣膠帶包住未使用電線的端子。
• การป้องกันการลัดวงจร จะต้องพันขั้วสายตะกั่วที่ไม่ใช้แล้วด้วยเทปพันสายไฟ
• من اجل منع التقصير في الدوائر الكهربائية، ضع شريط عازل ولاصق على اطراف الاسلاك غير المستعملة.

